

# Nokia Customer Care

## 9 — Schematics

(This page left intentionally blank.)

## Table of Contents

System connector.....	9-4
RETU.....	9-5
TAHVO.....	9-6
RAPGSM.....	9-7
Bluetooth.....	9-8
UI part 1.....	9-9
UI part 2.....	9-10
RF part.....	9-11
Audio, IHF, Vibra.....	9-12
SIM interface.....	9-13
IrDA interface.....	9-14
MMC interface.....	9-15
CMT memories.....	9-16
Camera.....	9-17

■ System connector

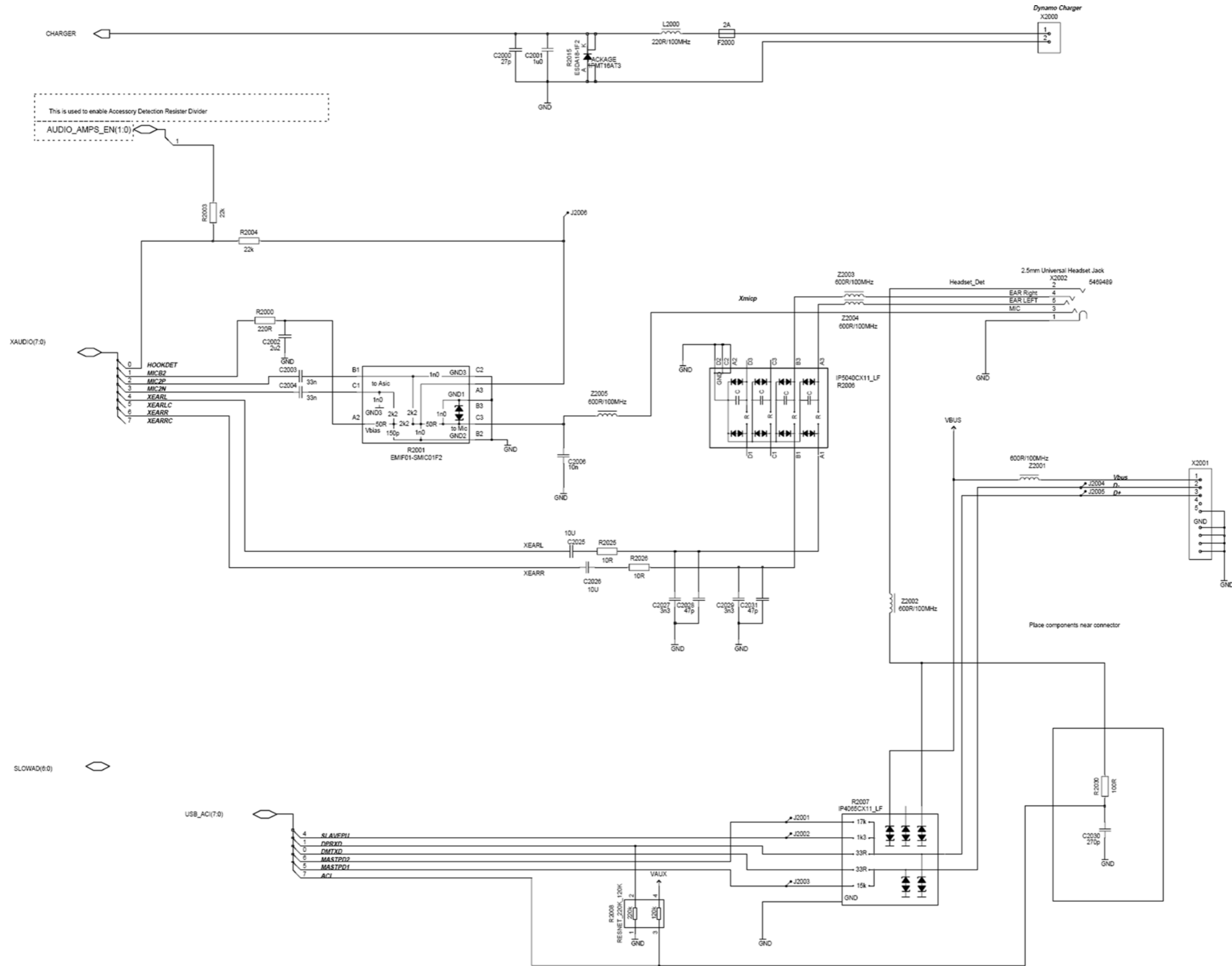

■ RETU

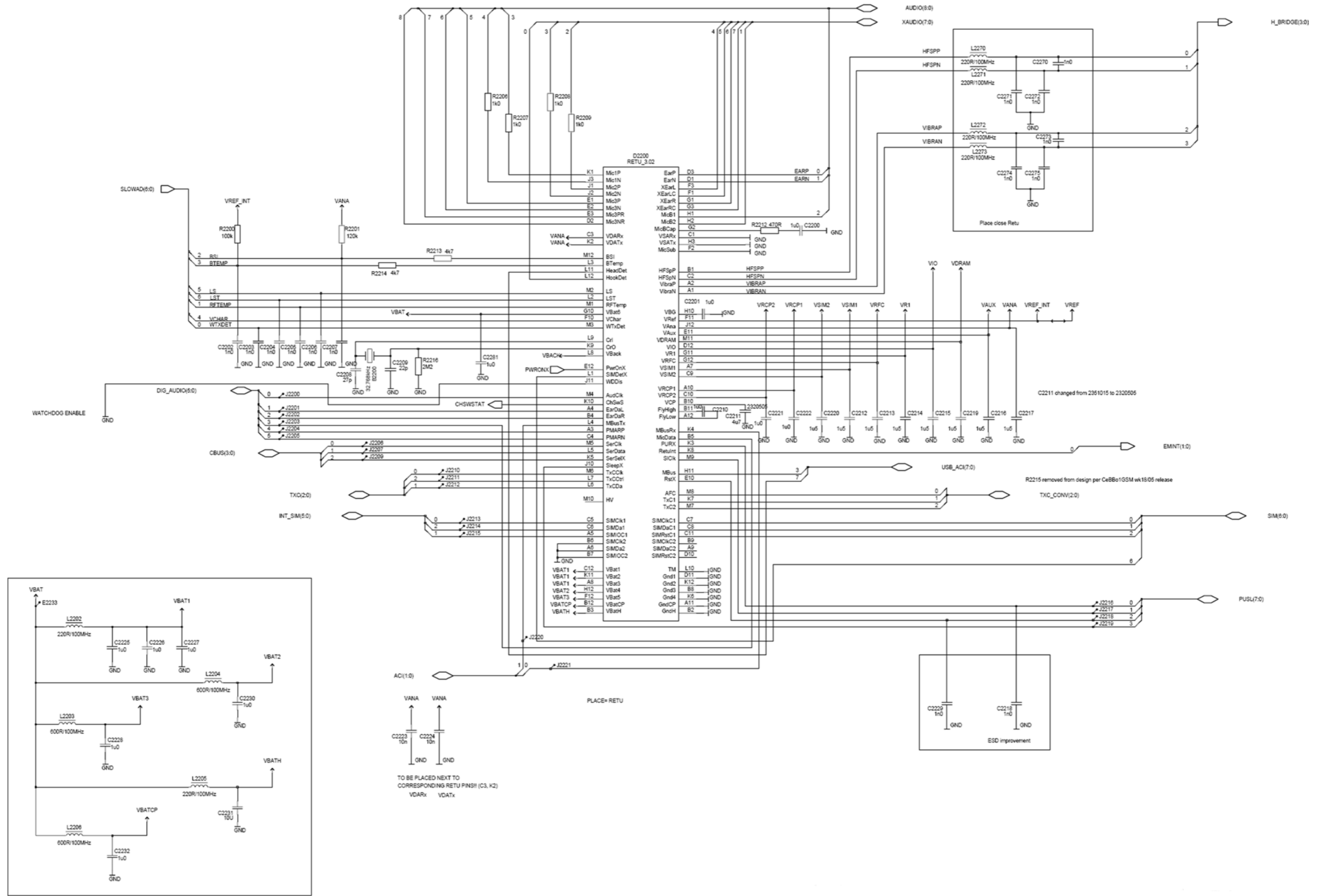

■ **TAHVO**

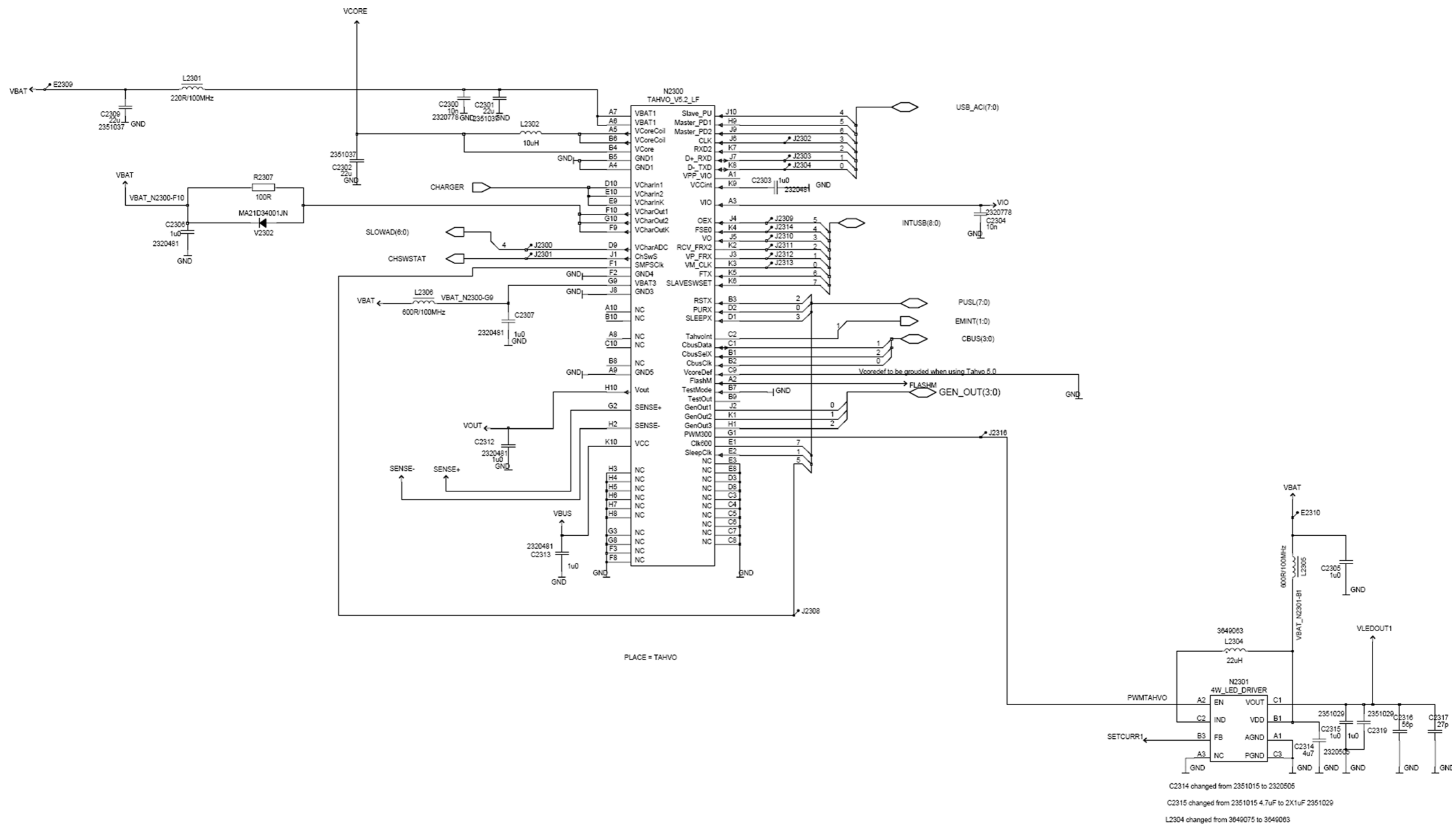

RAPGSM

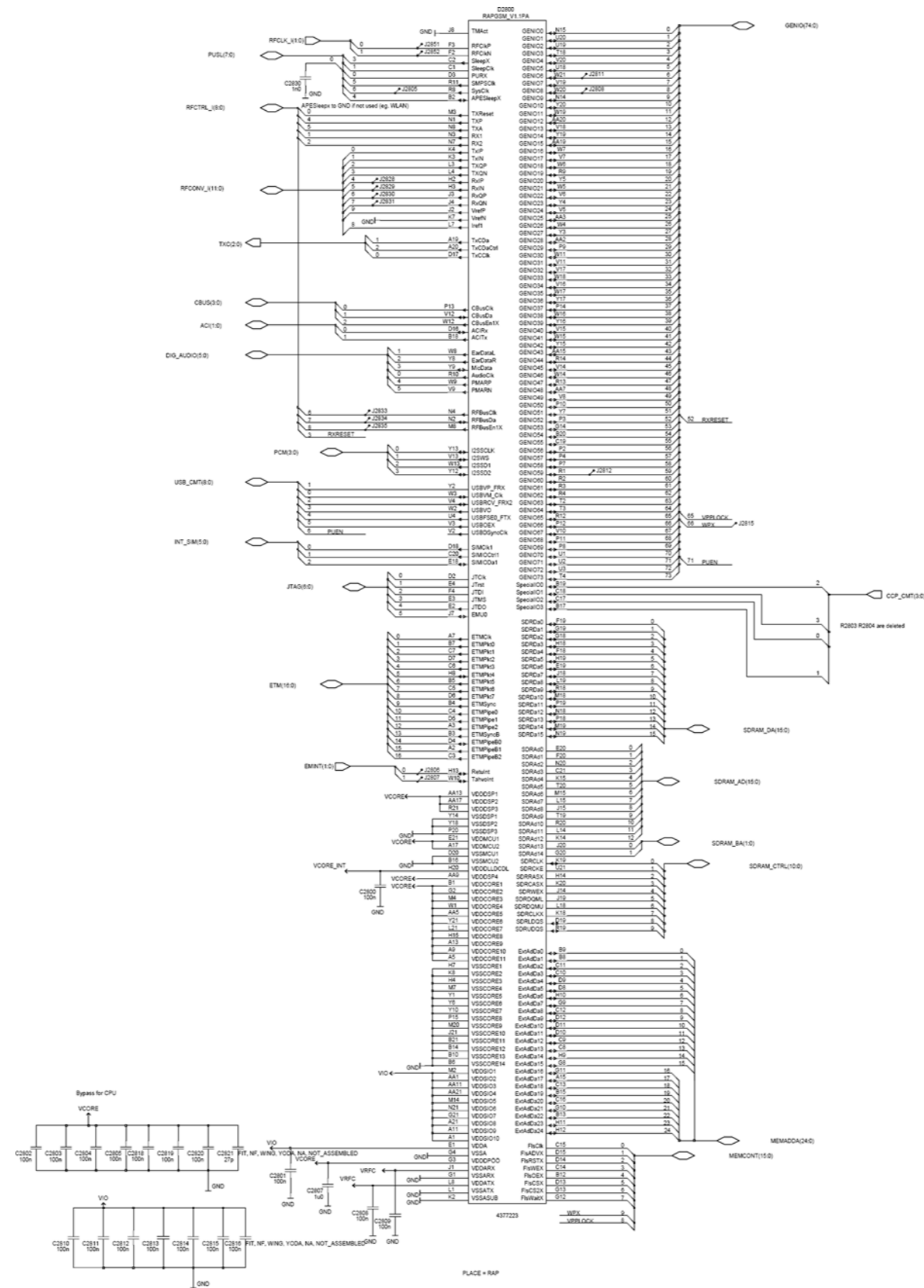

Bluetooth

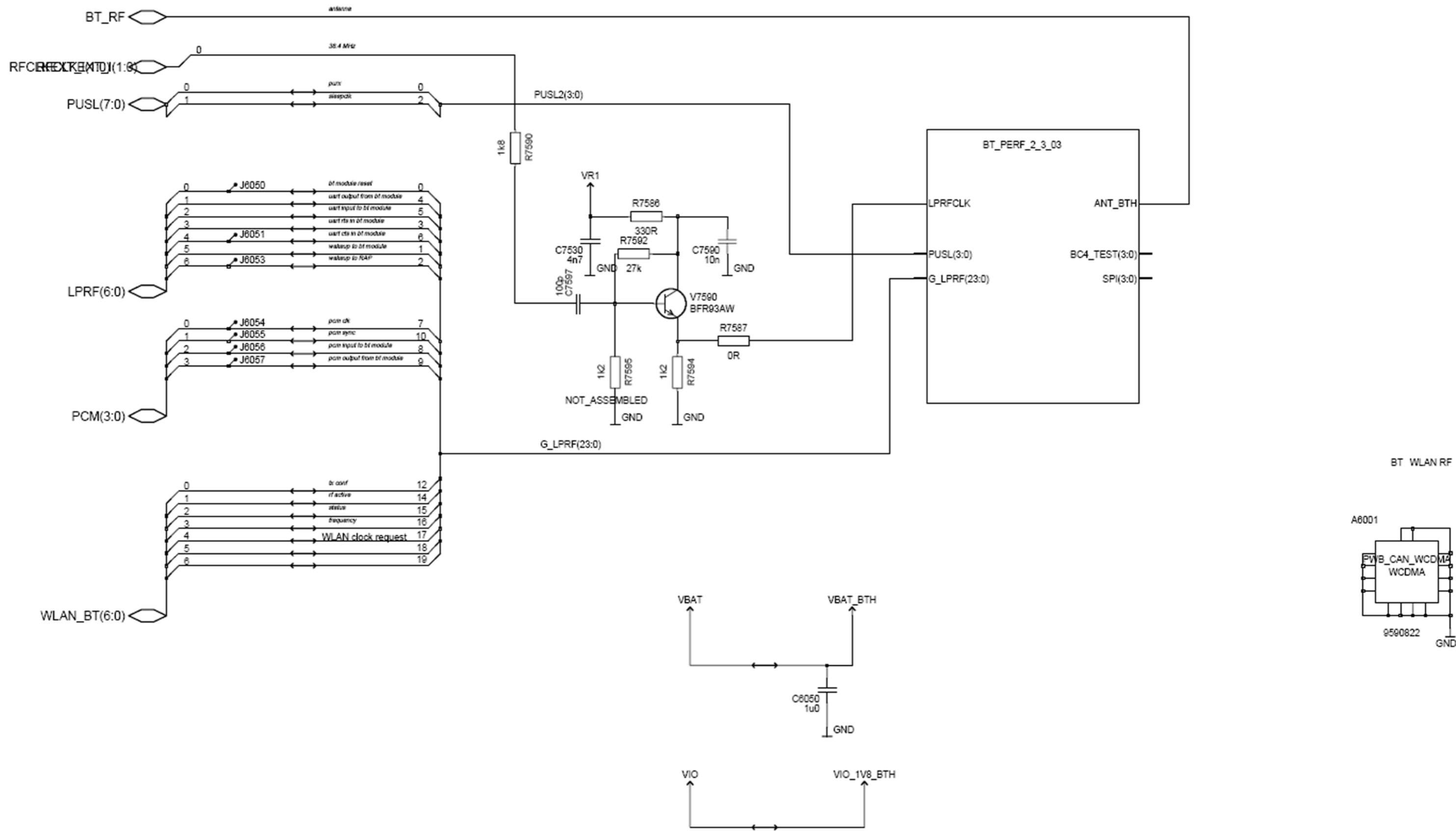



UI part 1

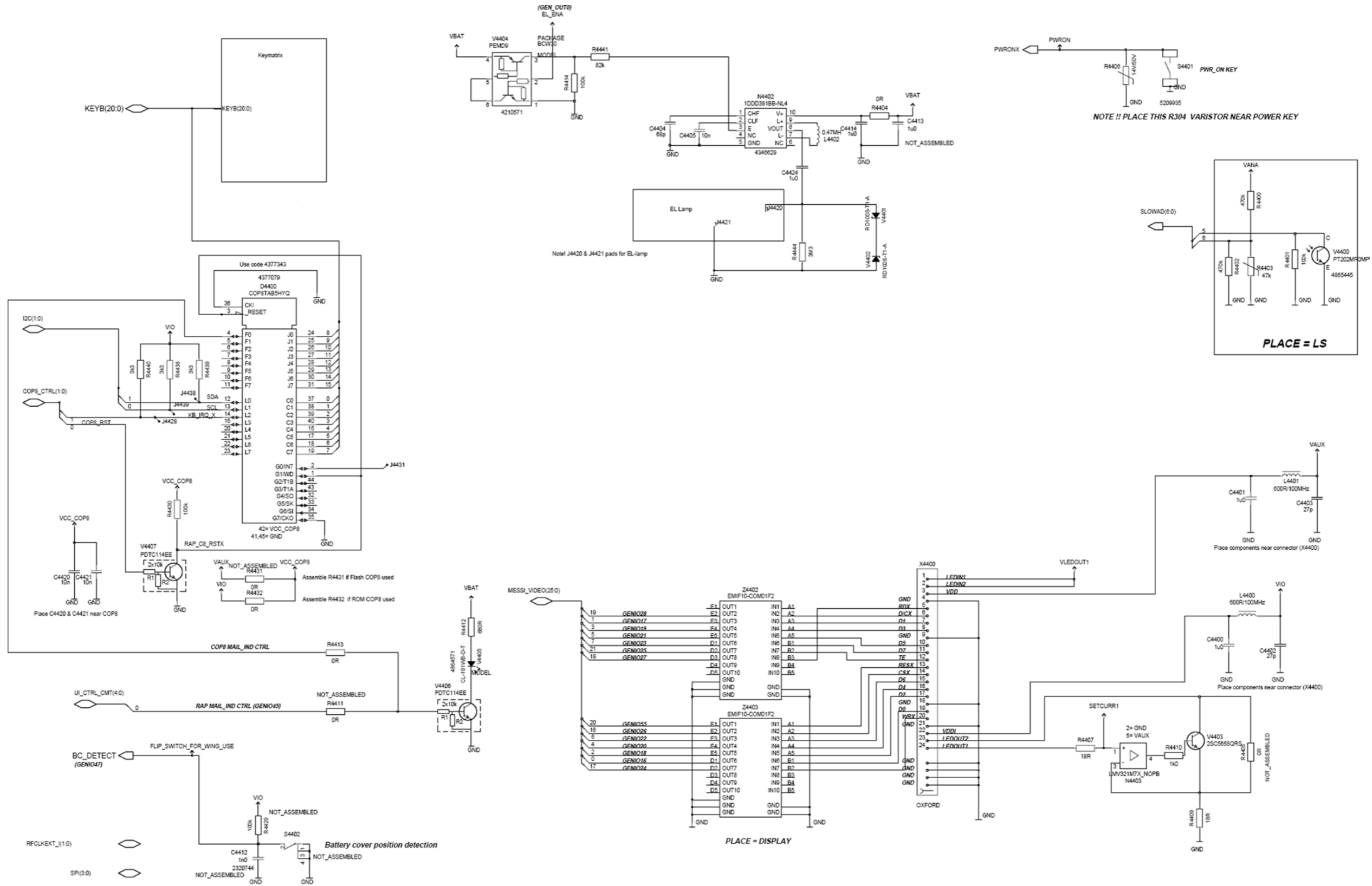

■ UI part 2

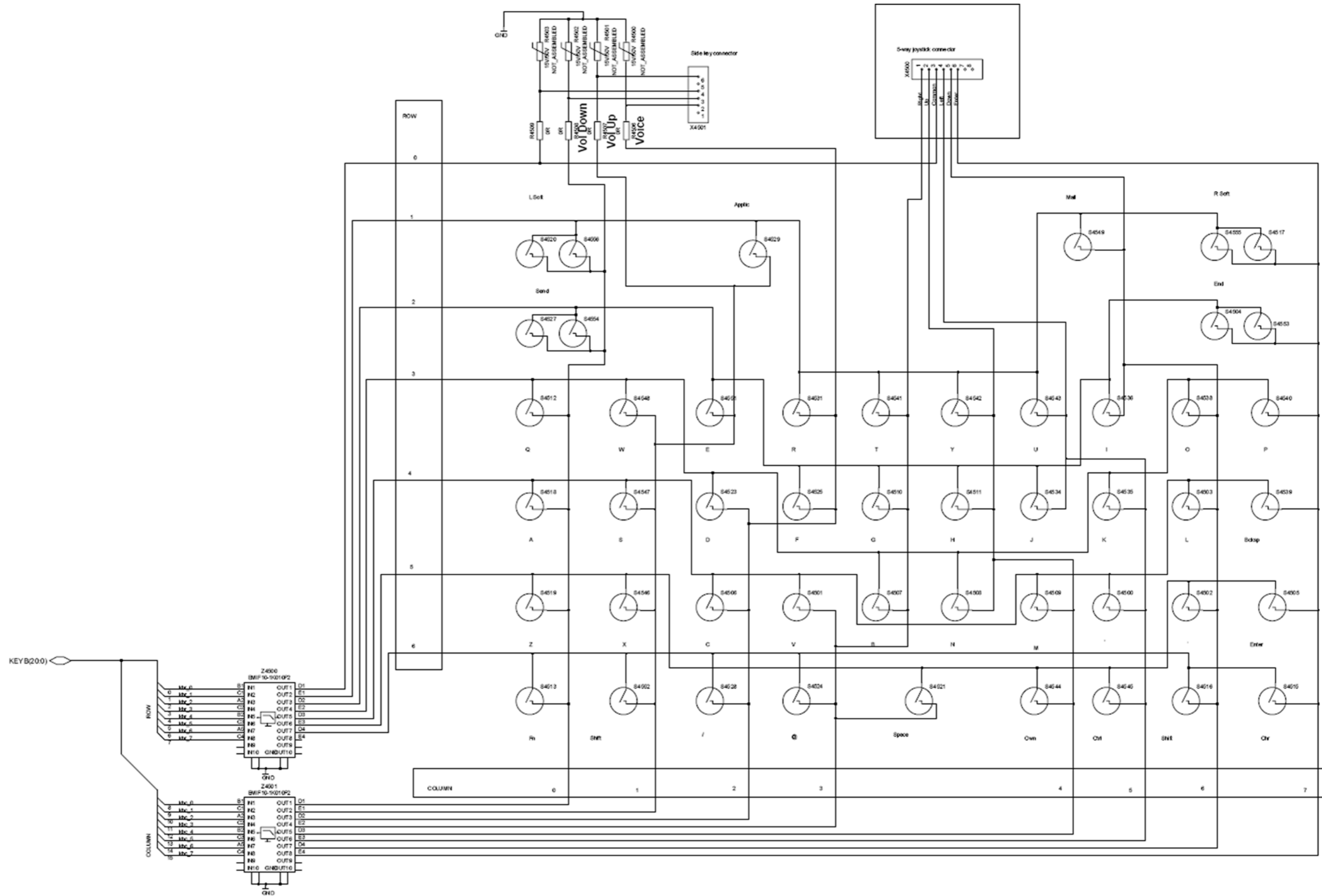

■ RF part

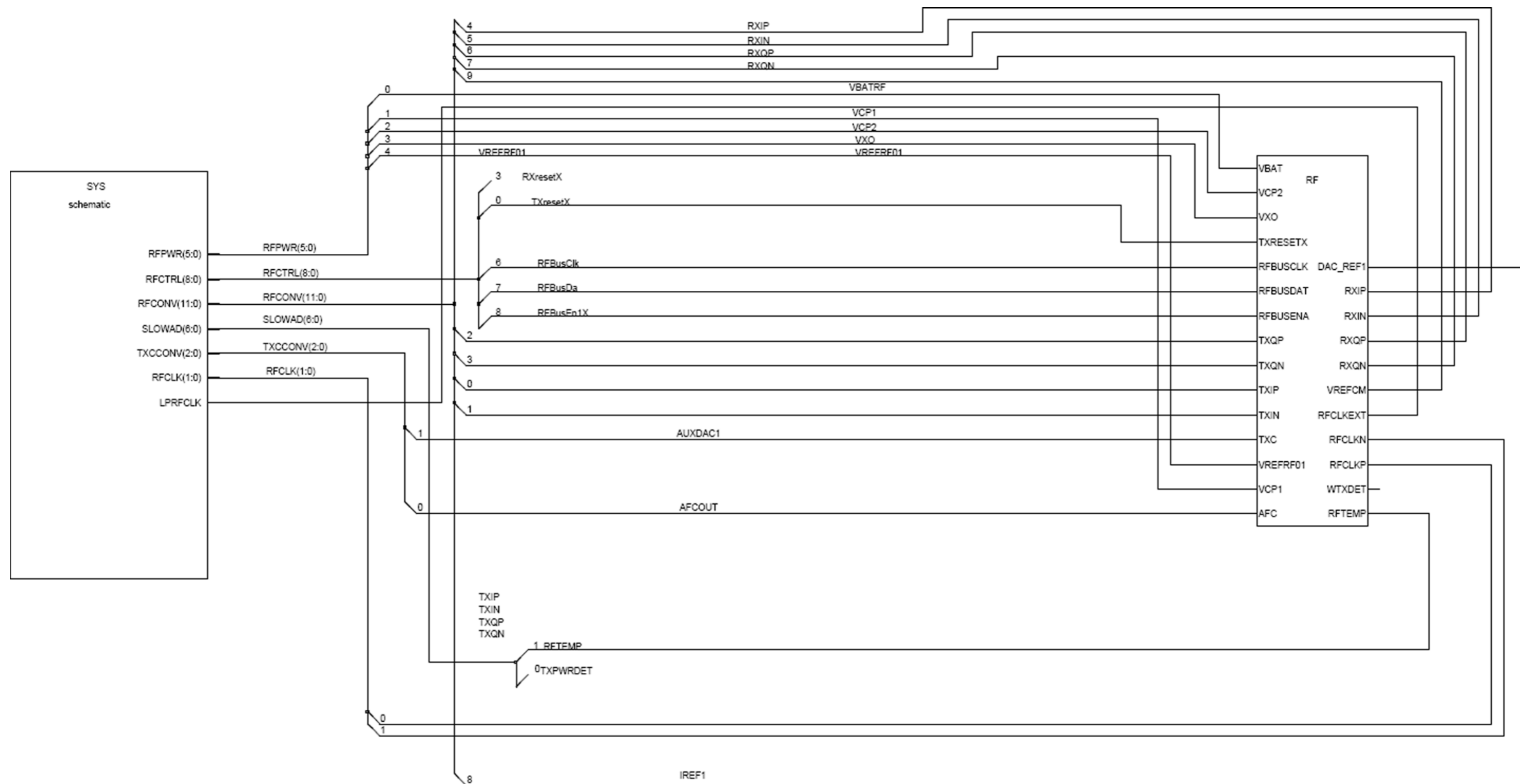

■ Audio, IHF, Vibra

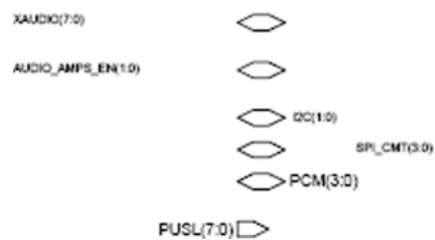
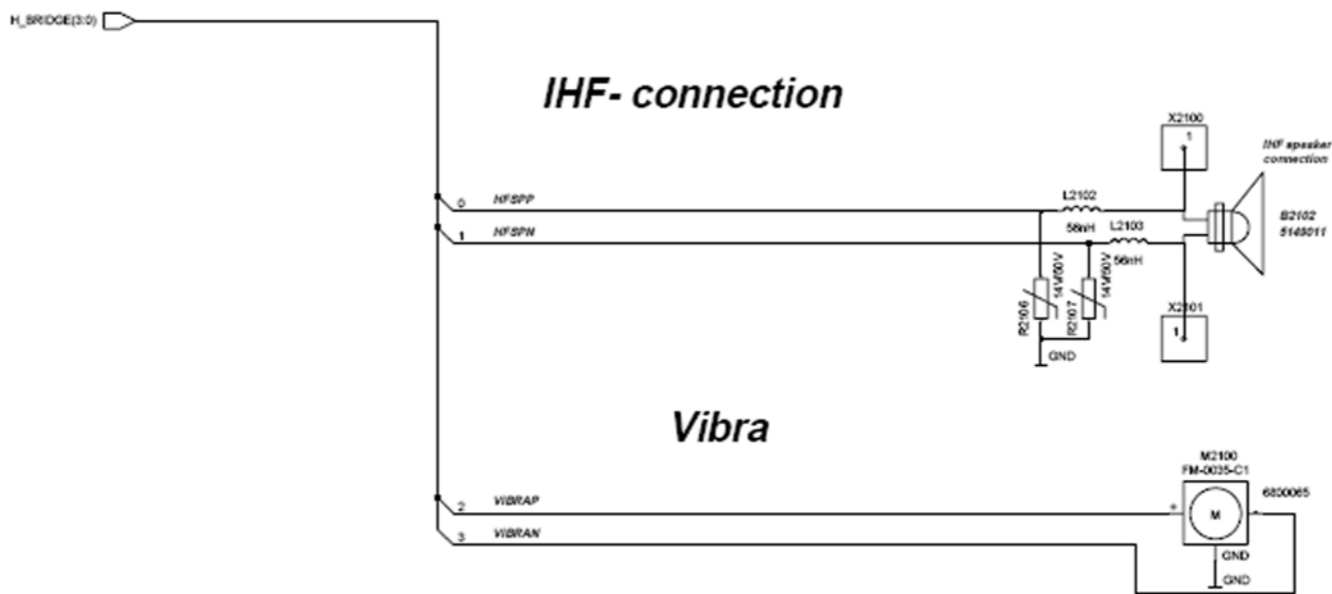
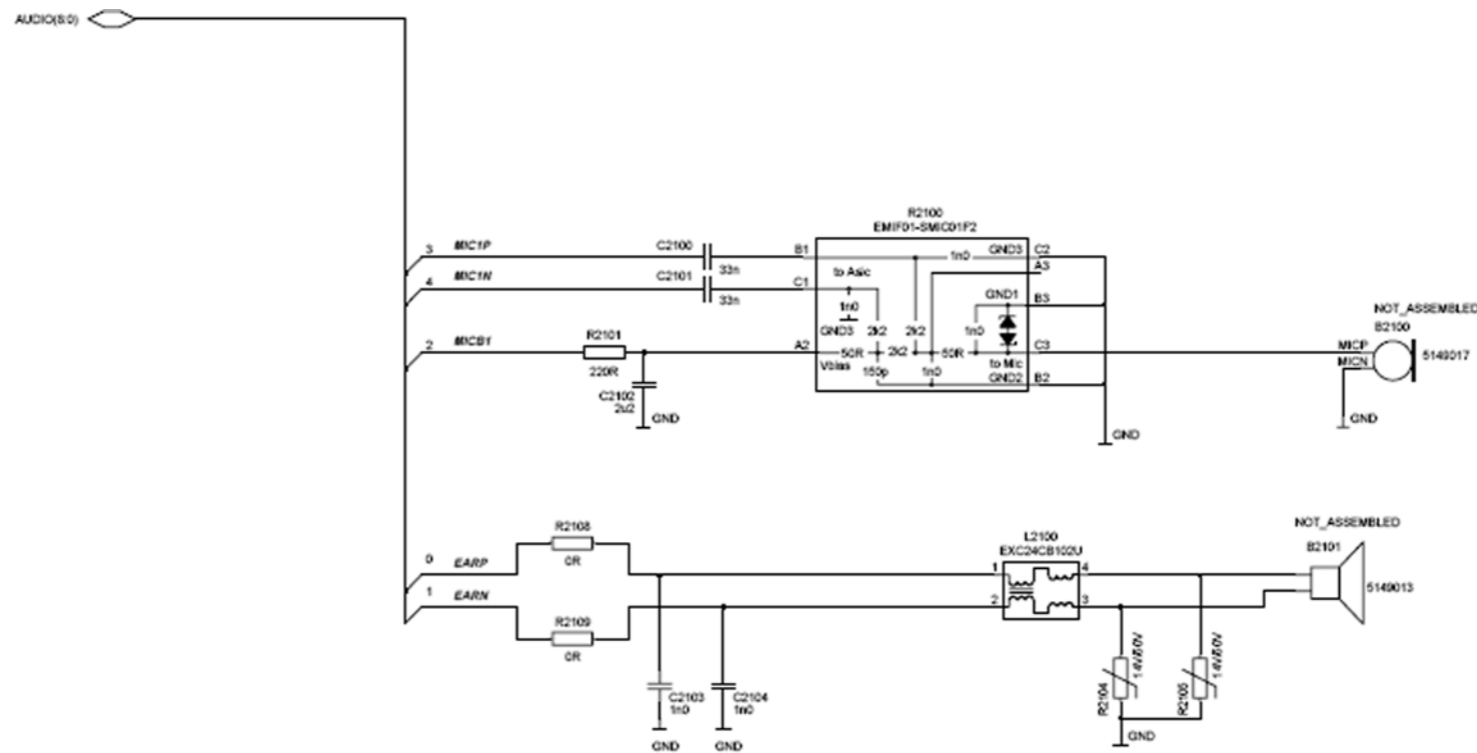

■ SIM interface

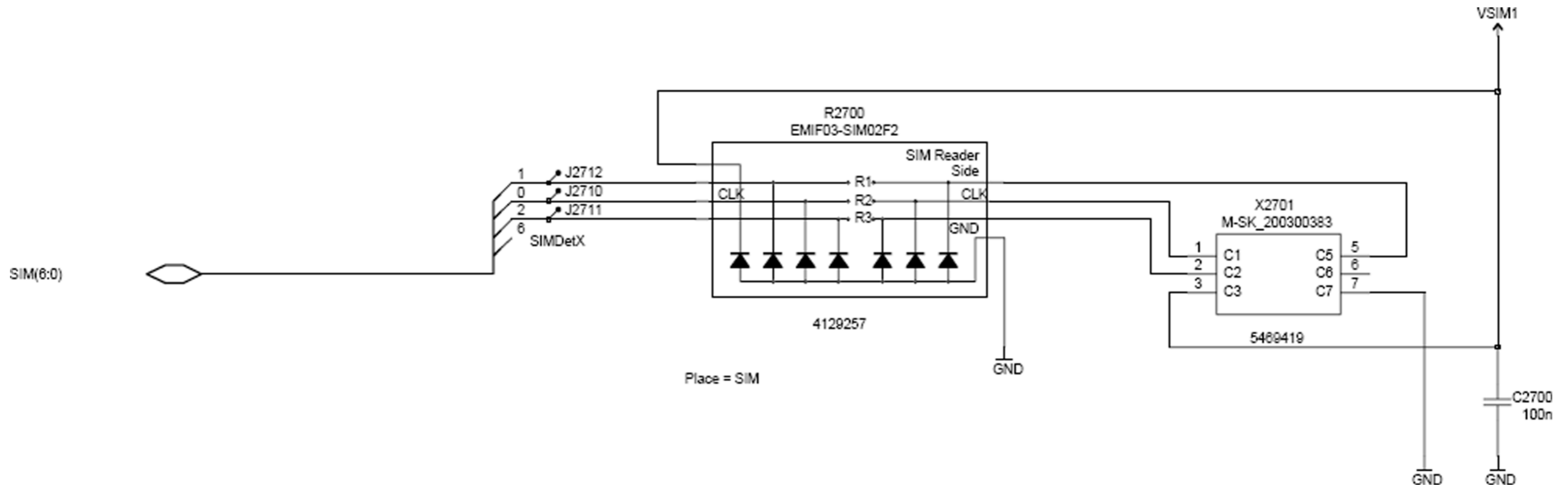

■ IrDA interface

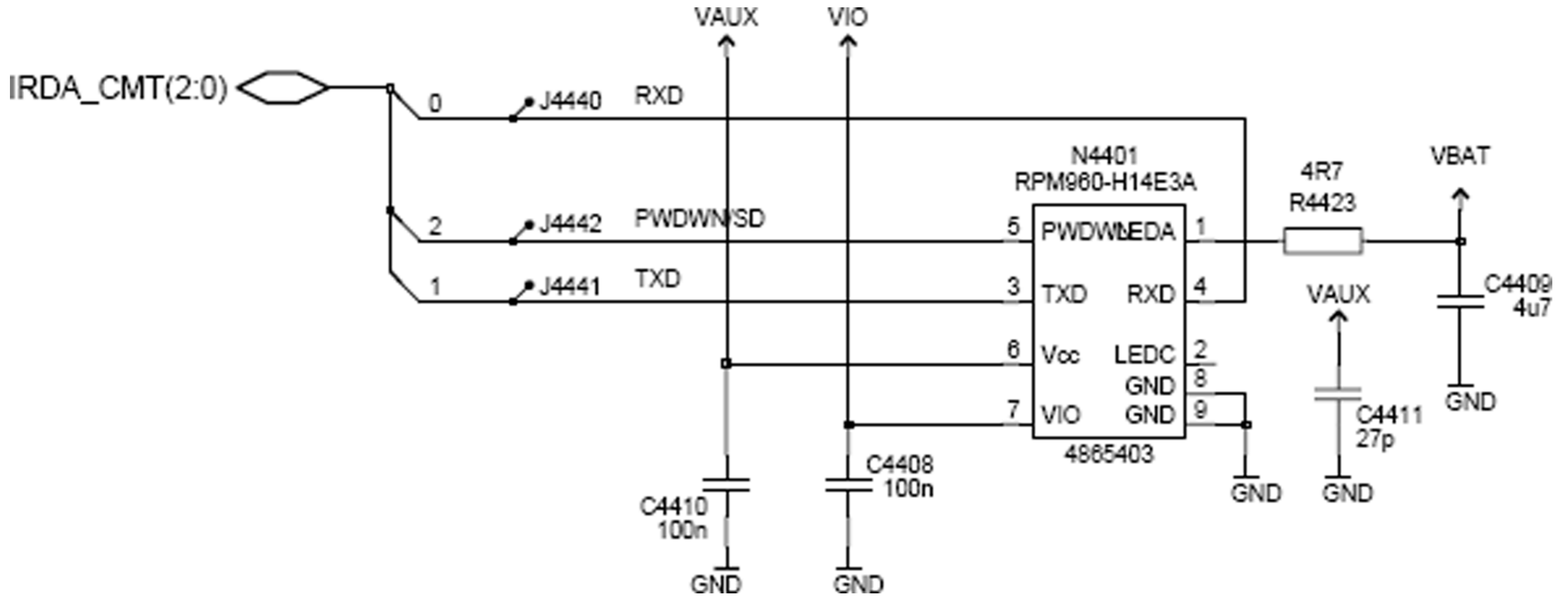

■ **MMC interface**

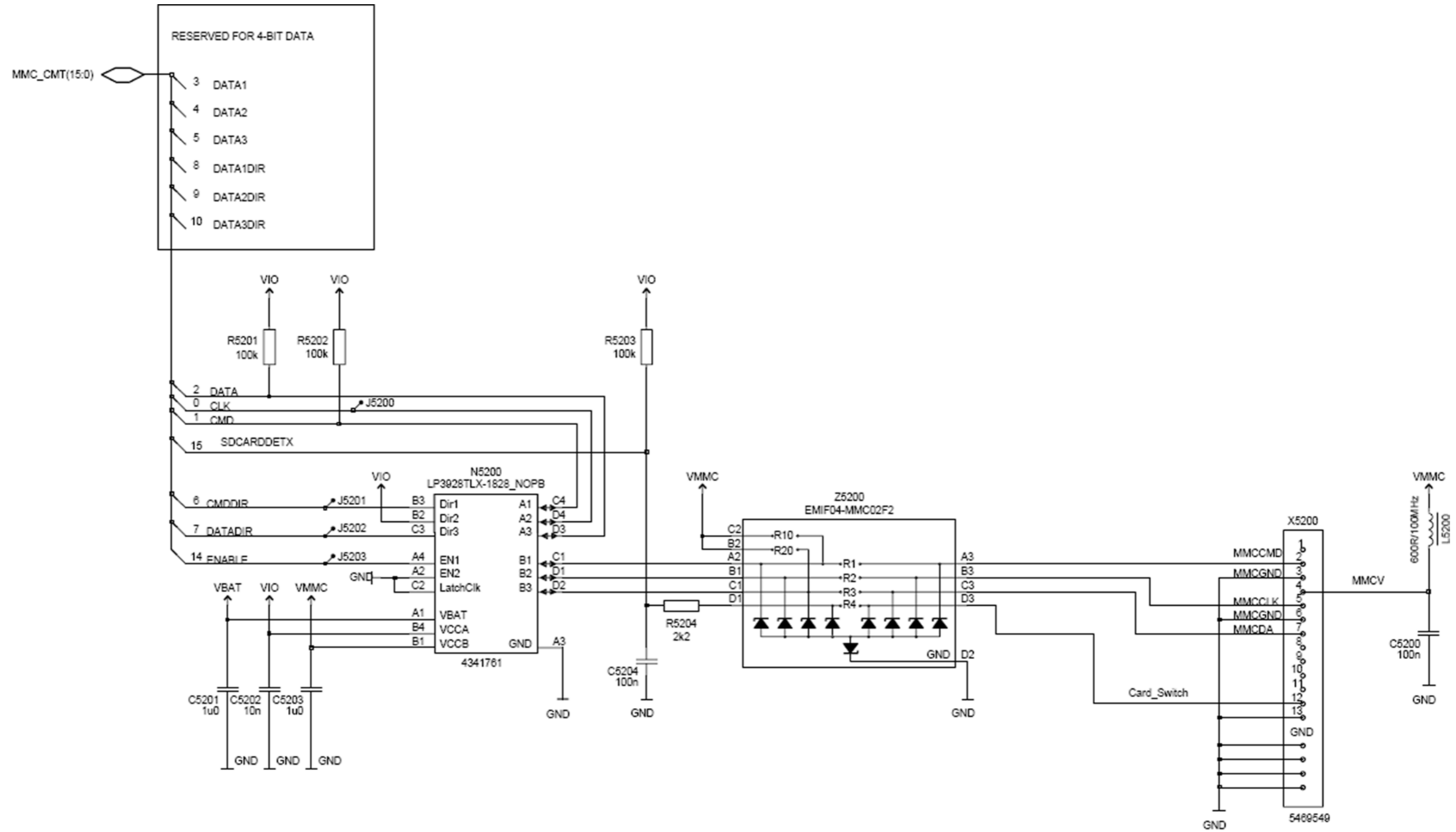

CMT memories

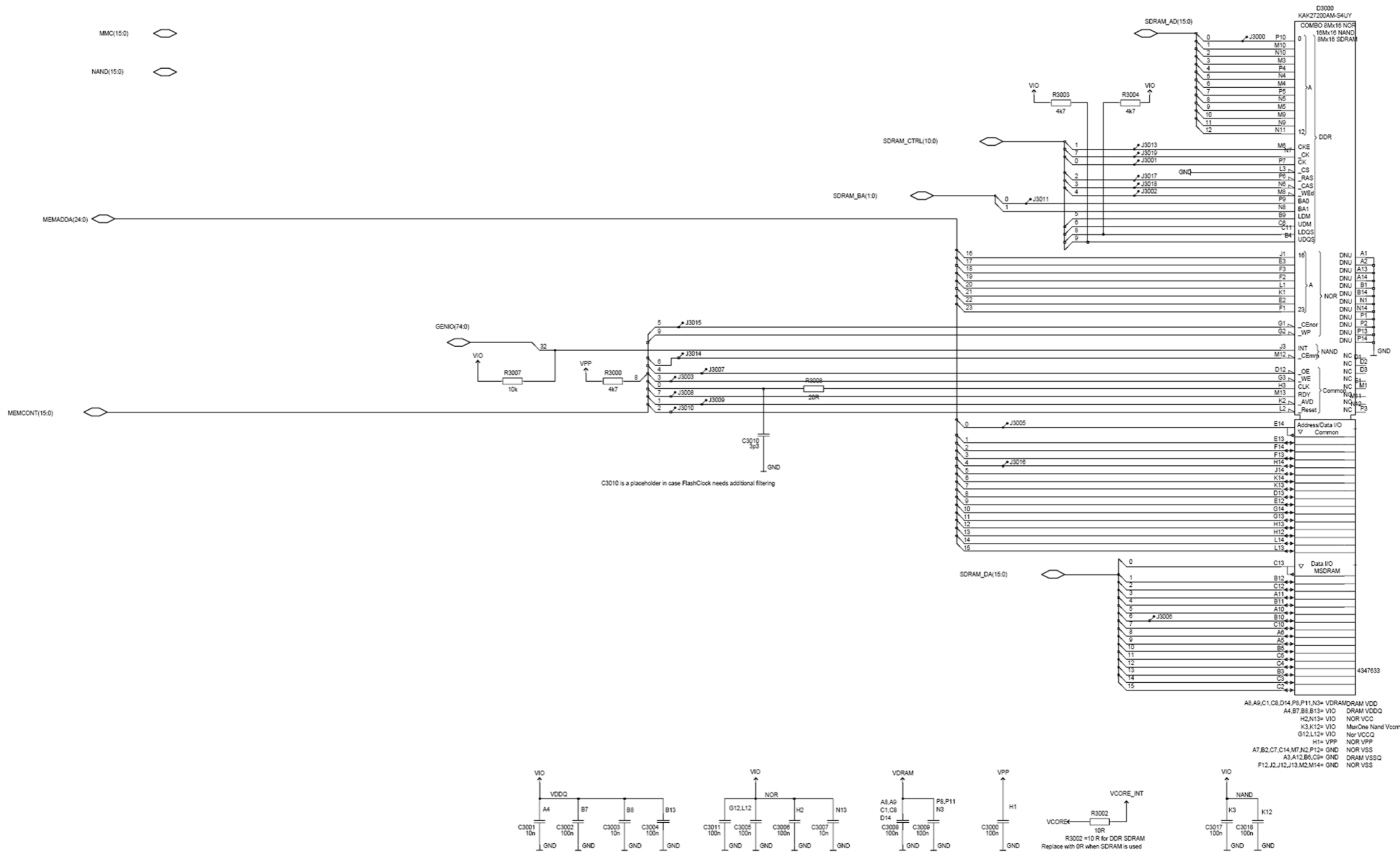



■ Camera

UI\_CTRL\_CMT(4:0)



I2C(1:0)



CCP\_CMT(3:0)



CAM\_CTRL\_CMT(4:0)



