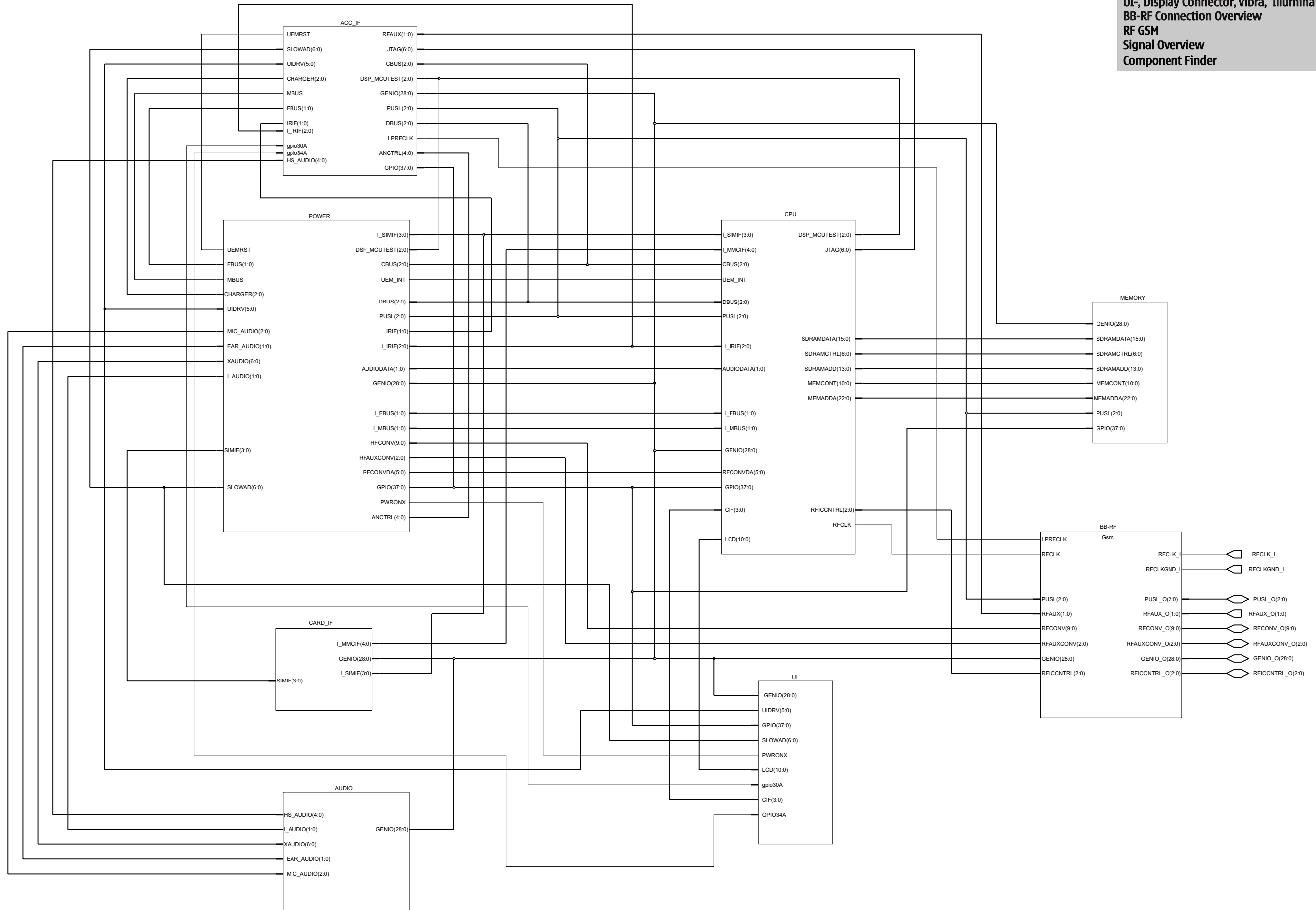
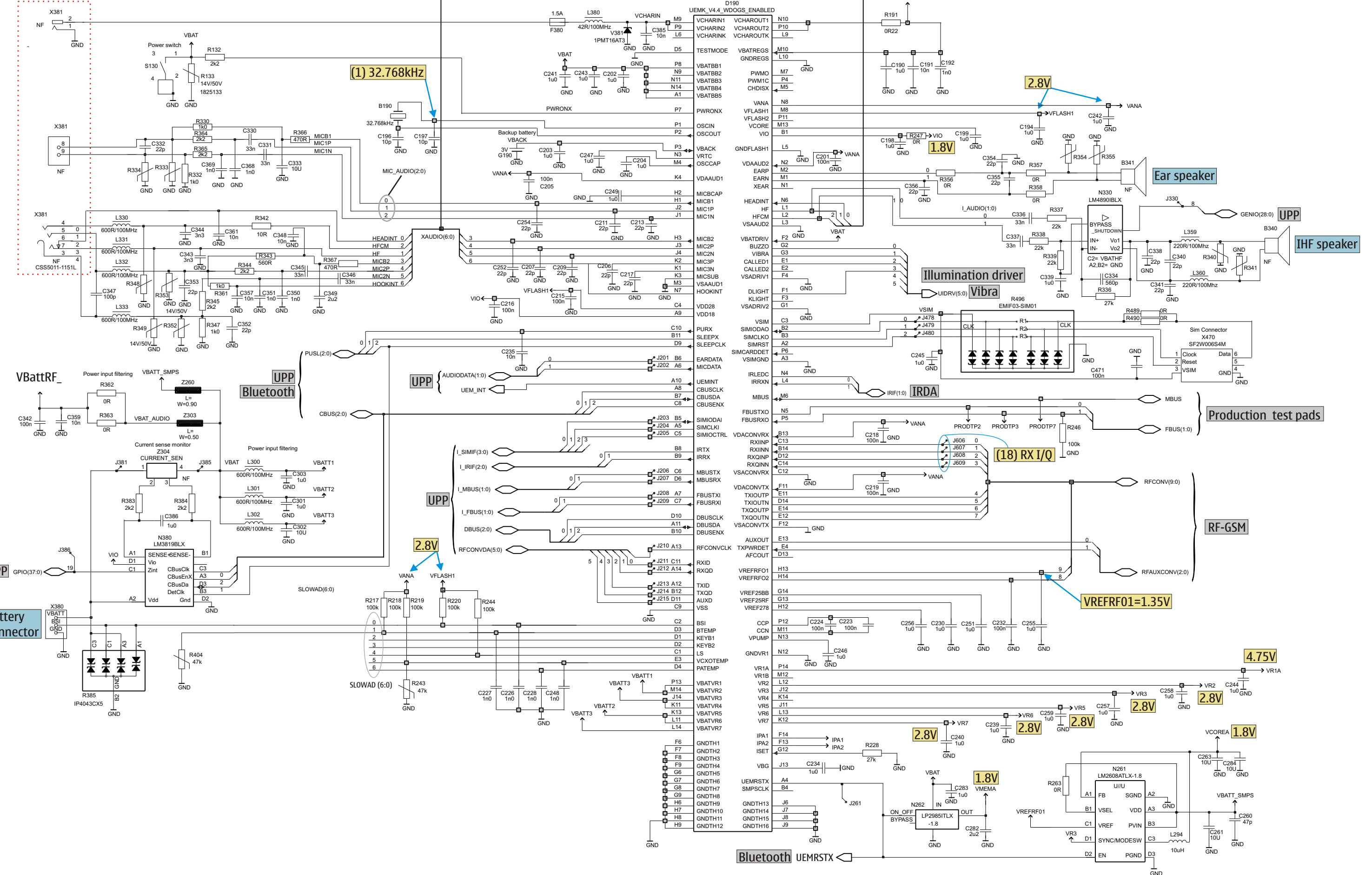

Table of Contents

Table of Contents	Page
DCT-4 Common Baseband	1
UEM, Bottom Connector, SIM	2
UPP, Flash, Bluetooth, Irda, Camera	3
FLASH, SDRAM	4
UI-, Display Connector, Vibra, Illumination driver	5
BB-RF Connection Overview	6
RF GSM	7
Signal Overview	8
Component Finder	9



Bottom connector



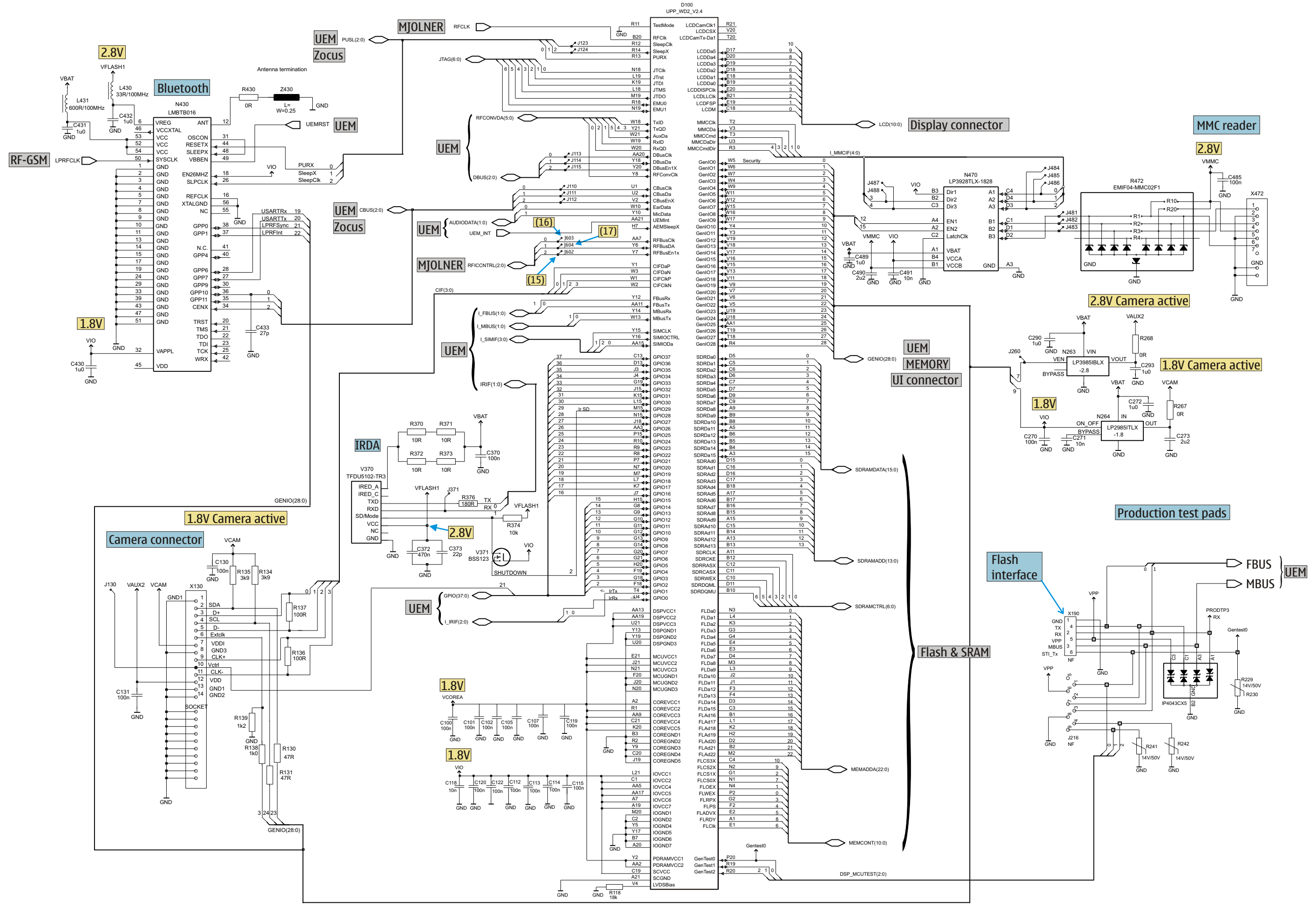

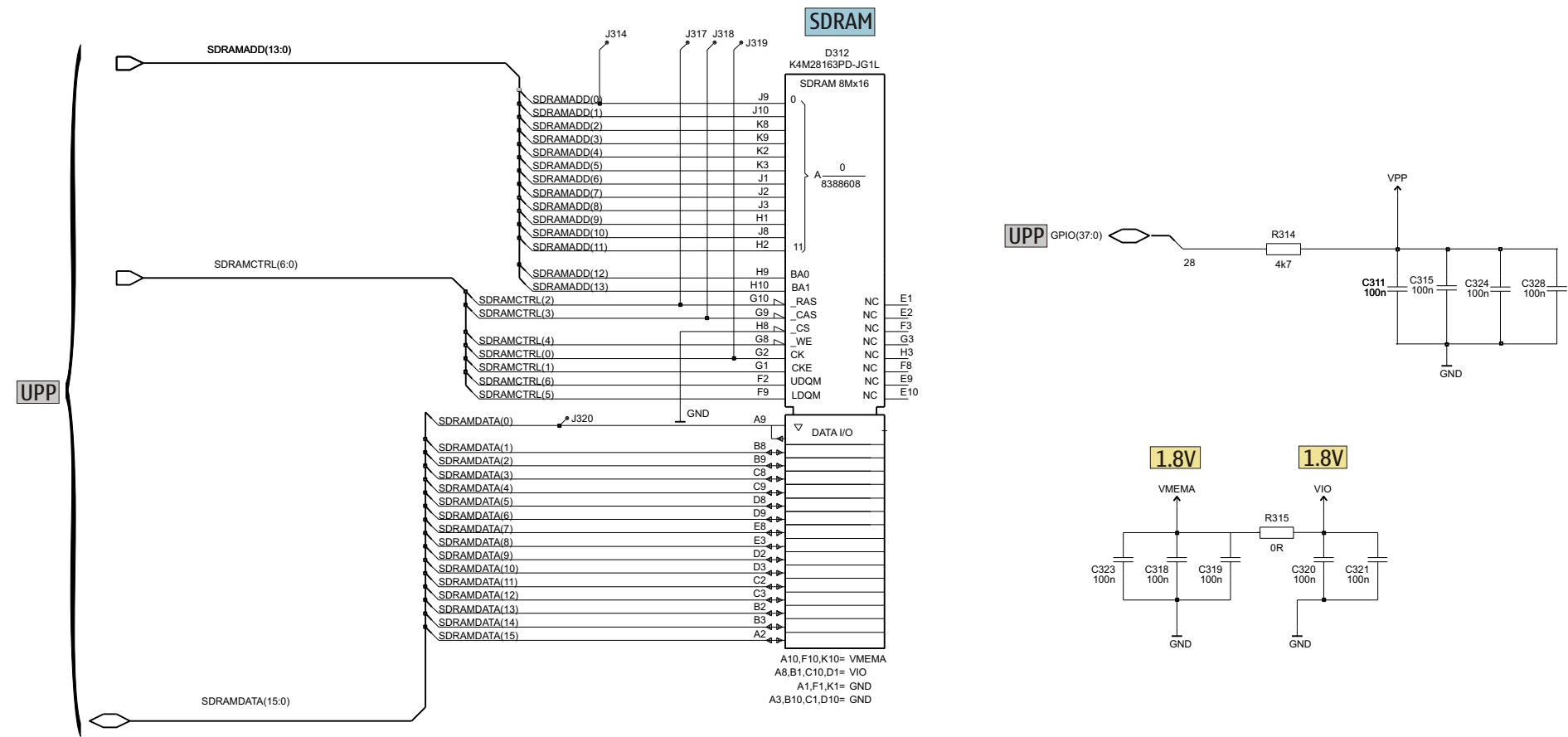
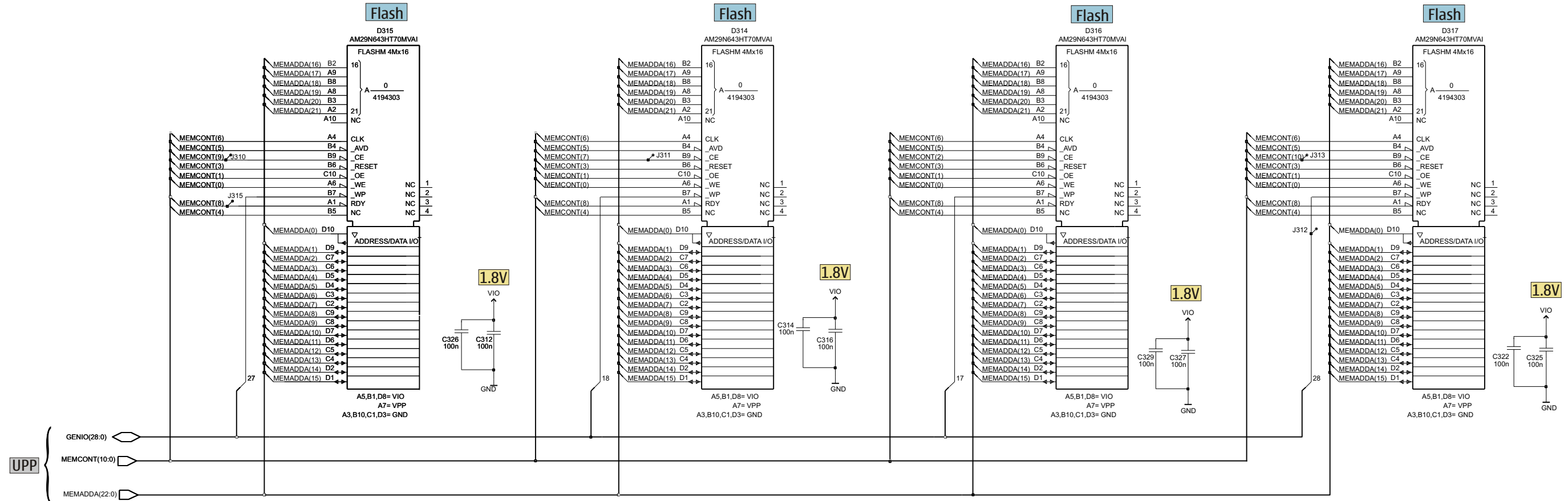

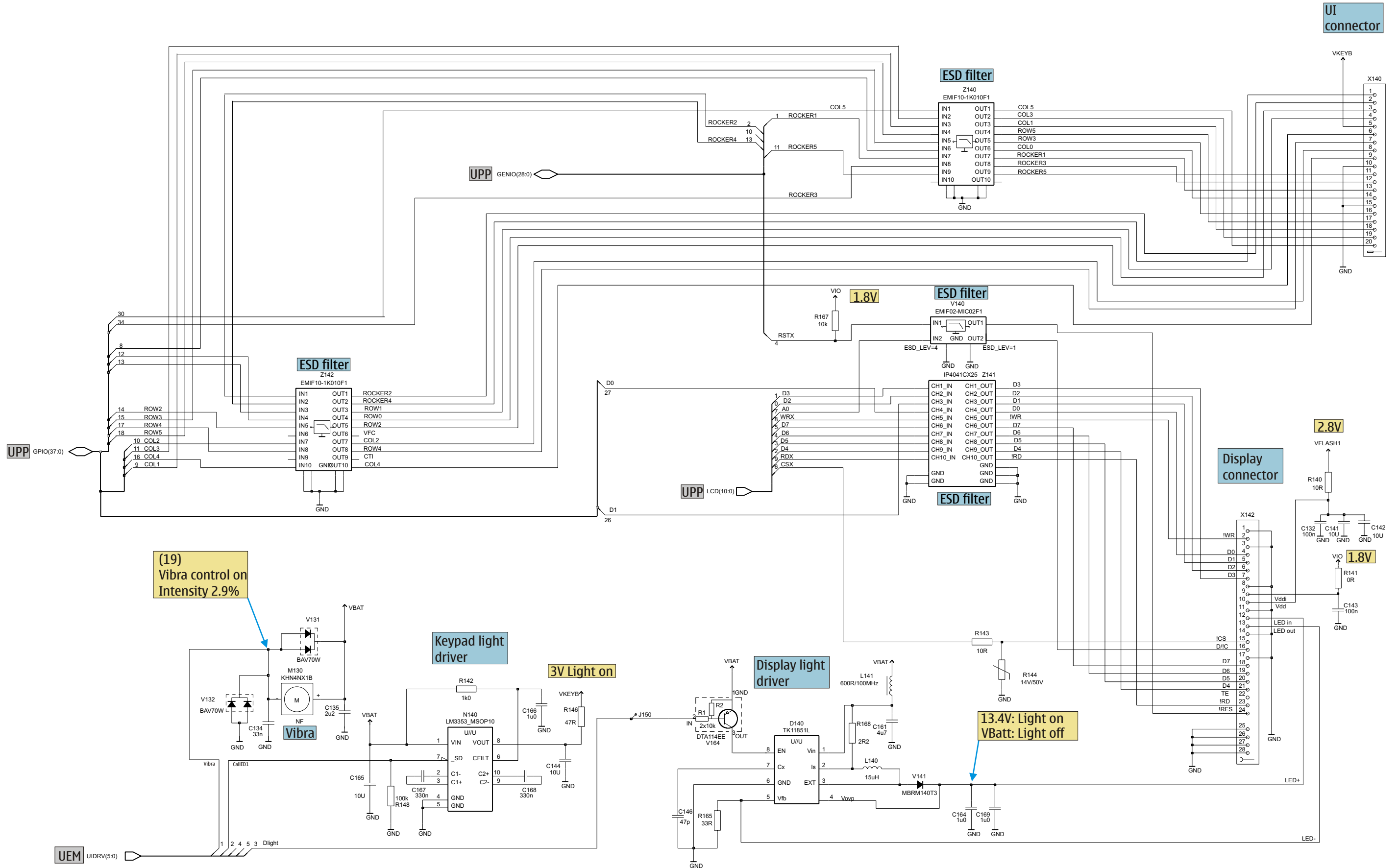

(19) Vibra control on Intensity 2.9%

13.4V: Light on VBatt: Light off

Keypad light driver

Display light driver

3V Light on

UEM UIDRV(5:0)

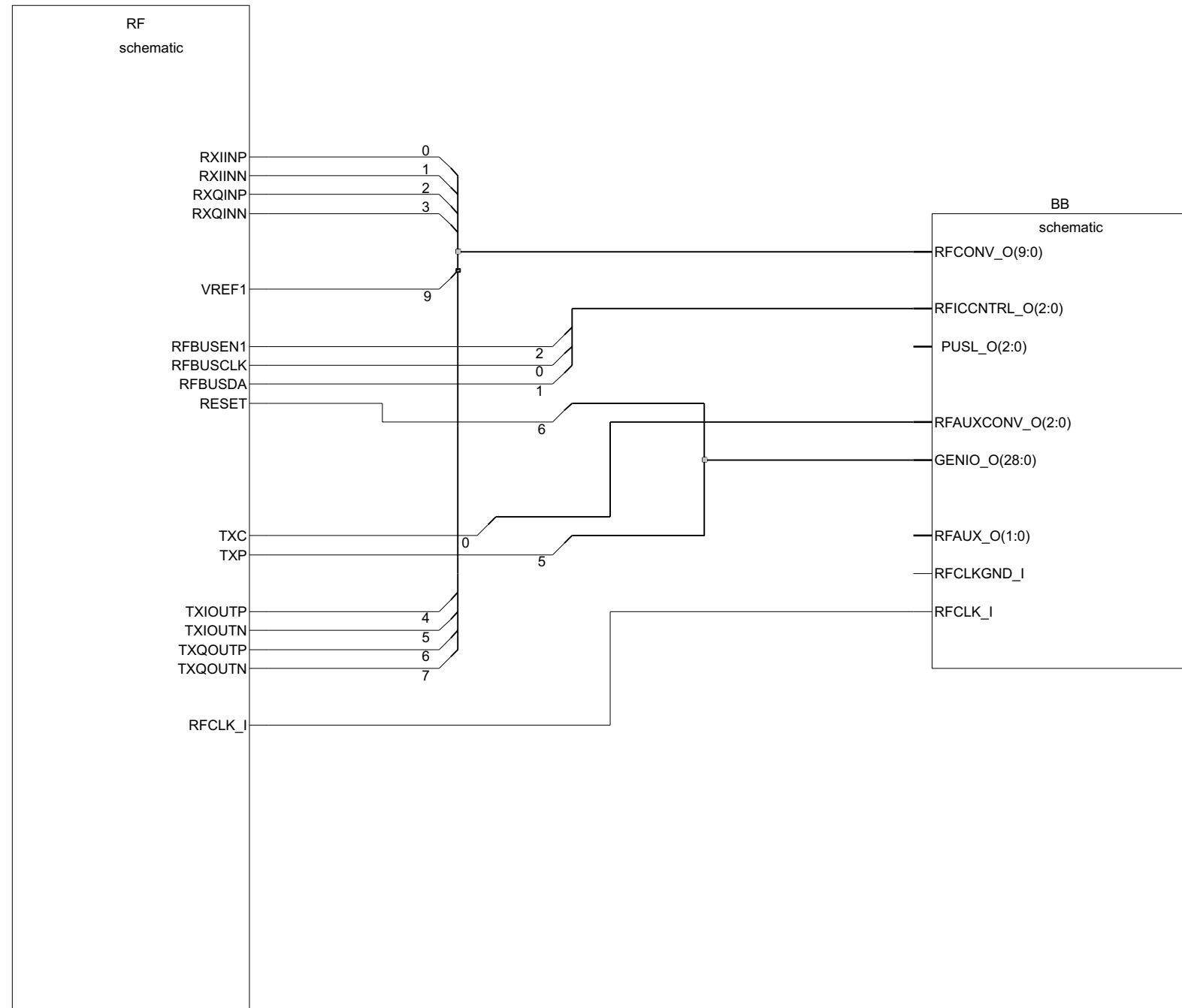

Band	Channel	RX	VCO/RX	VC/RX	TX	VCO/TX	VC/TX
EGSM 900	37	942,4MHz	3769,6MHz	~2,58V	897,4MHz	3589,6MHz	~1,8V
GSM 1800	700	1842,8MHz	3685,6MHz	~2,2V	1747,8MHz	3495,6MHz	~1,4V
GSM 1900	661	1960MHz	3920MHz	~3,2V	1880MHz	3760MHz	~2,54V

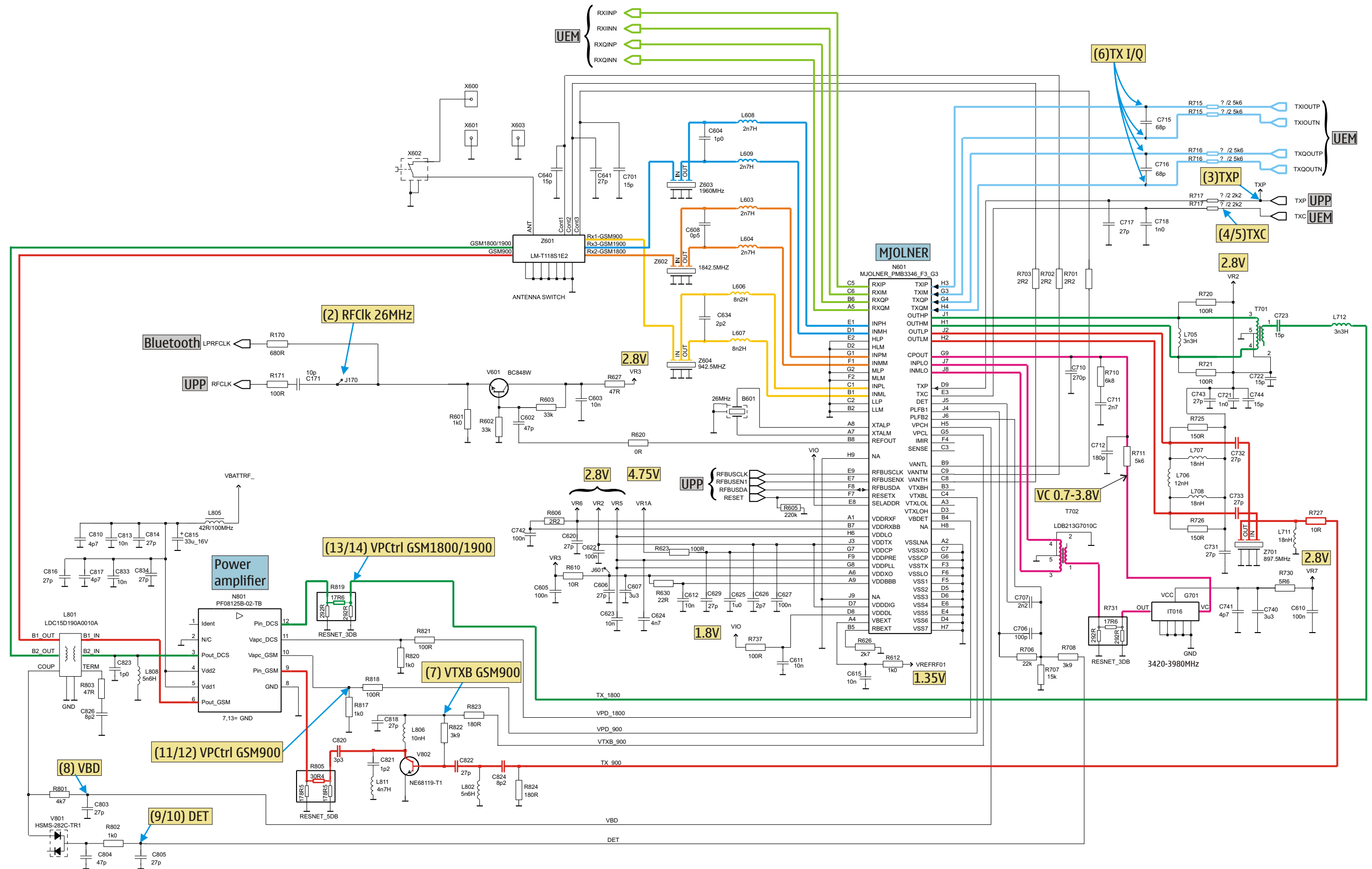

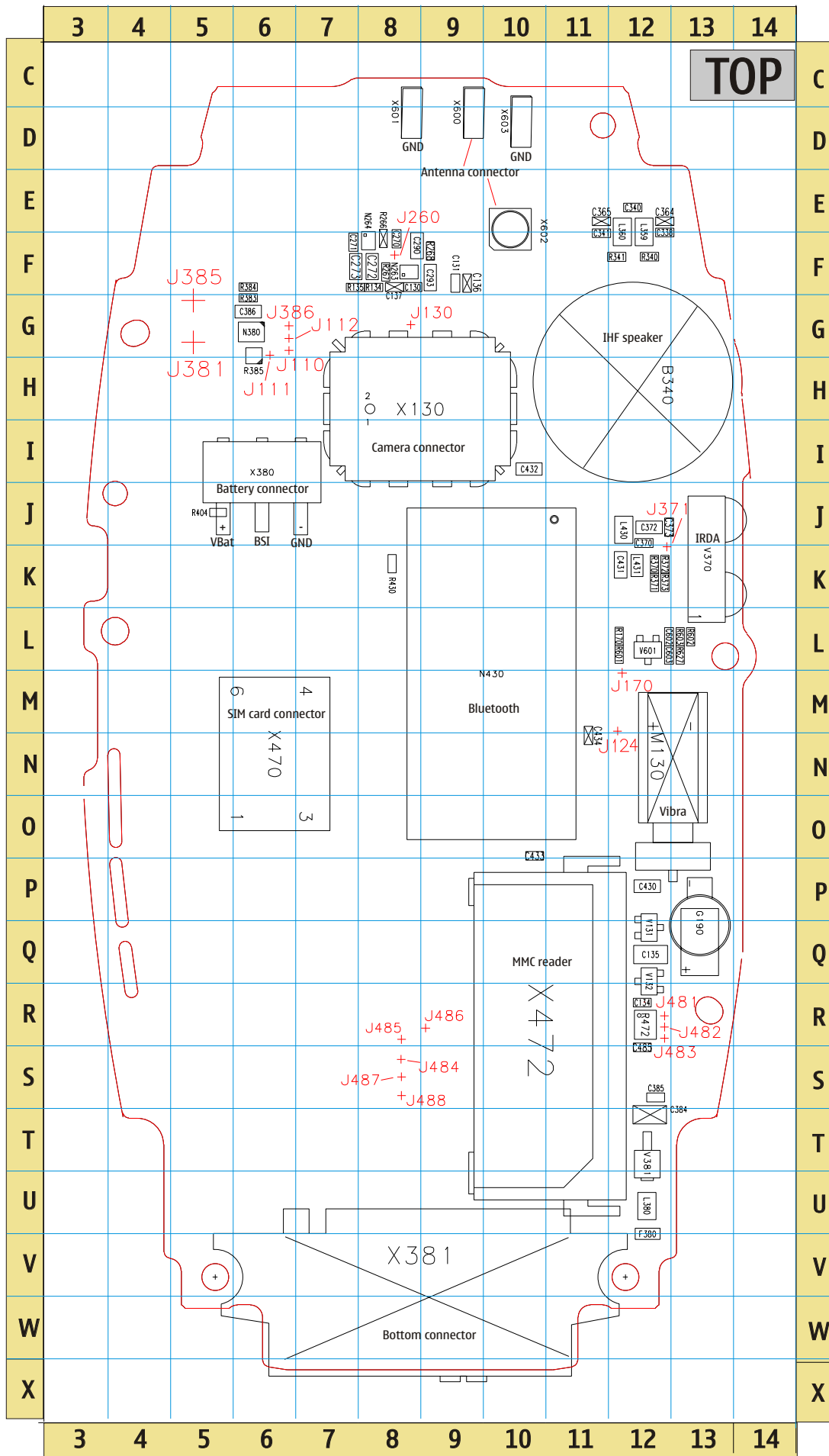

Table with 23 columns (B-X) and 27 rows (C-X) listing component values, values, and values for various components.

