

- GPS_CMT(3:0)
- PUSL(7:0)
- FCI_CMT(3:0)
- GPSCLK
- IRDA_CMT(2:0)
- I2C(1:0)
- RFID_CMT(1:0)
- PUSL(7:0)
- WLAN_CMT(7:0)
- LPRFCLK_I
- CBUS(3:0)

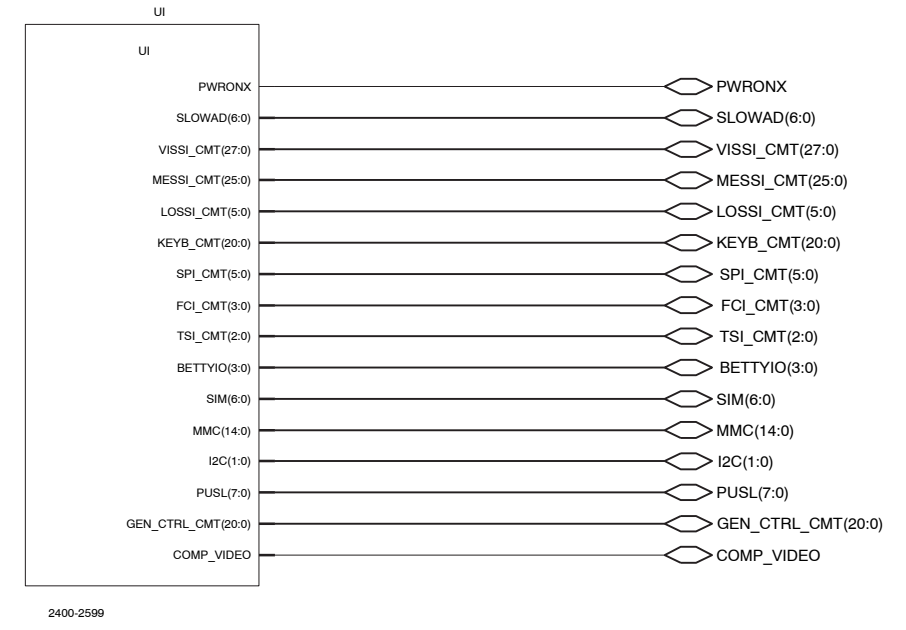

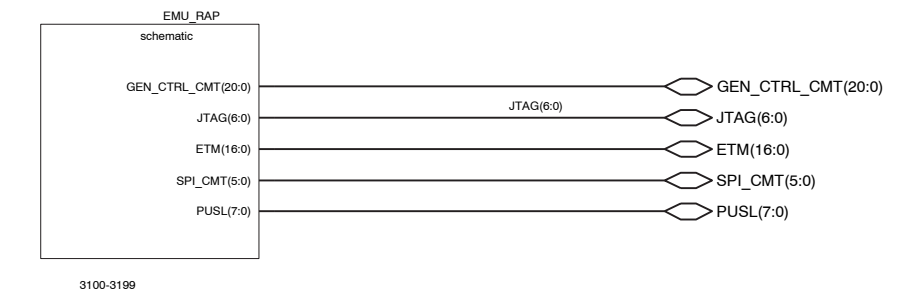

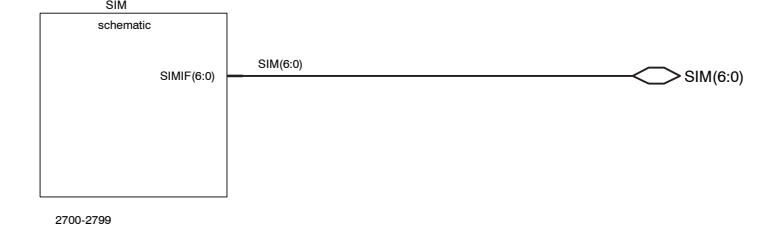

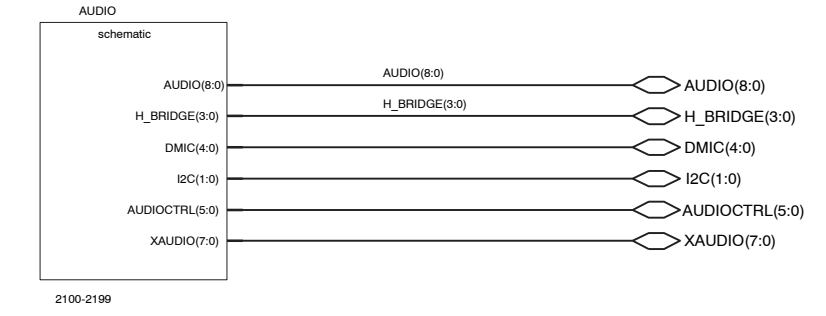
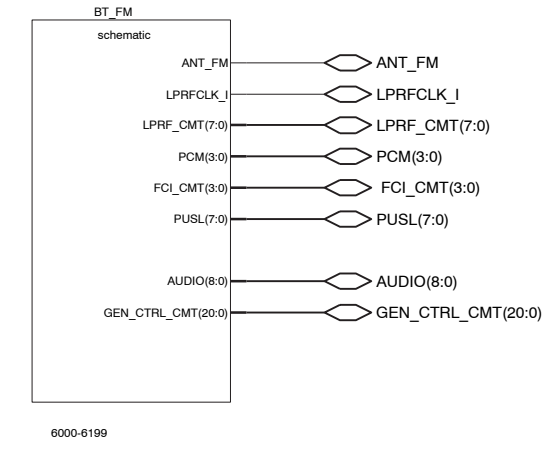
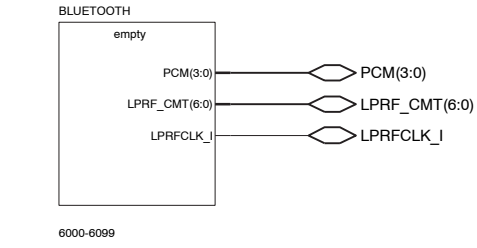
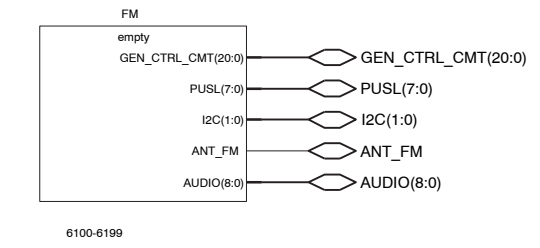
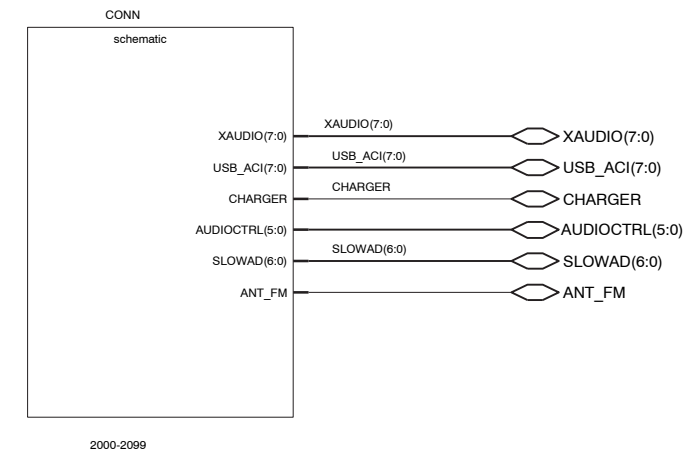
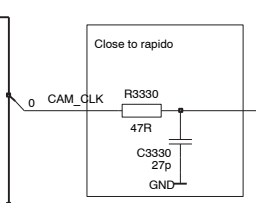
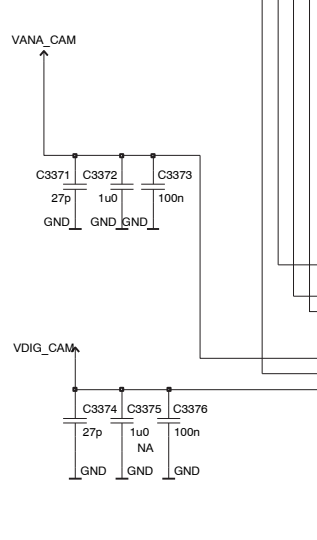
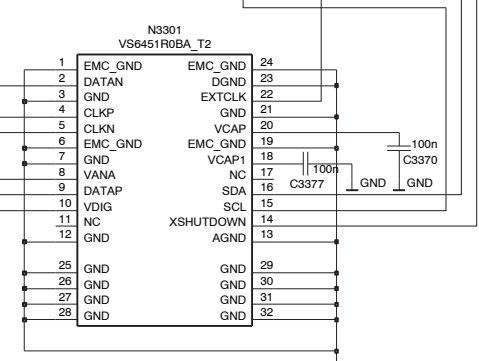
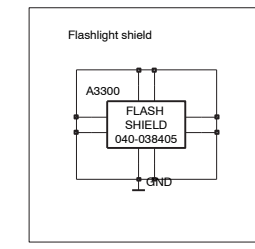
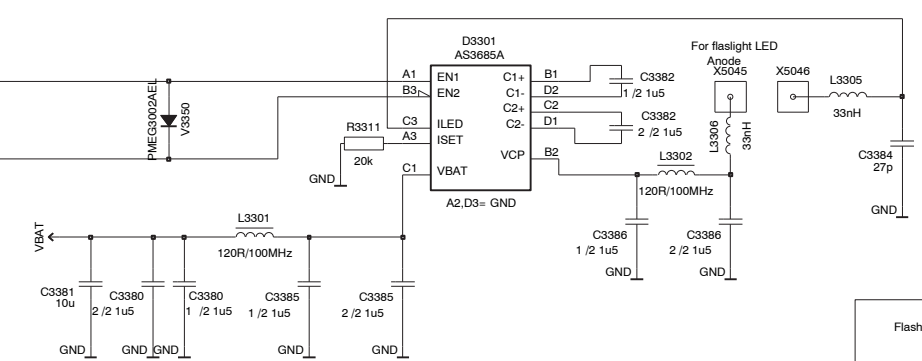
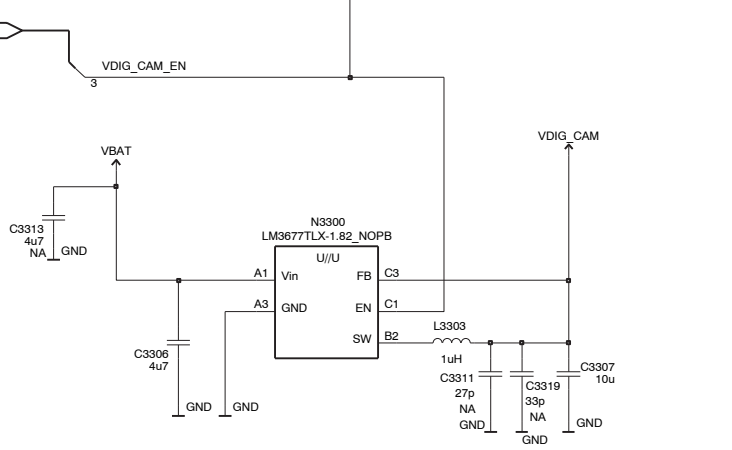
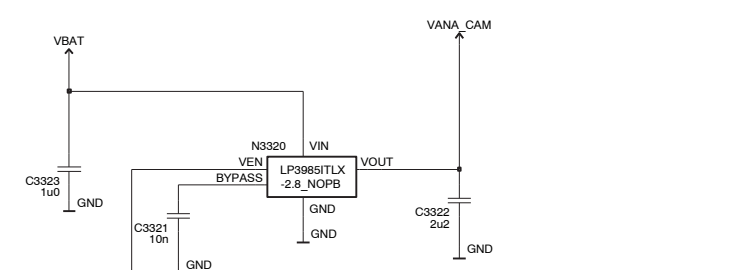
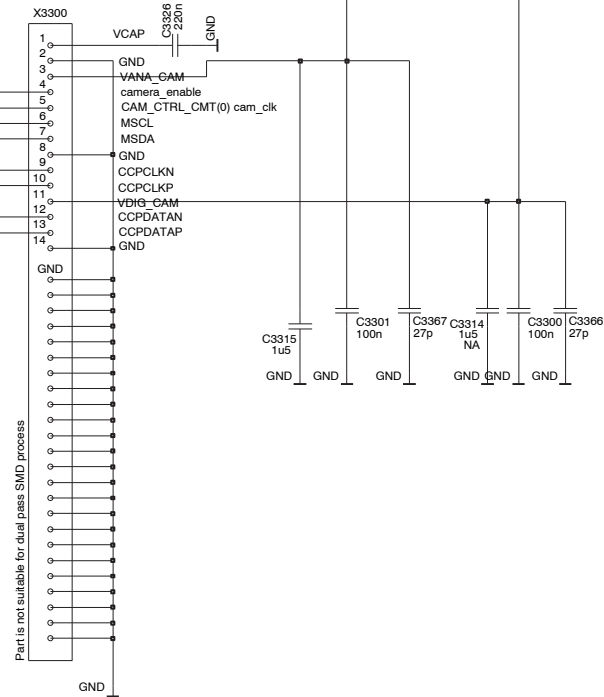
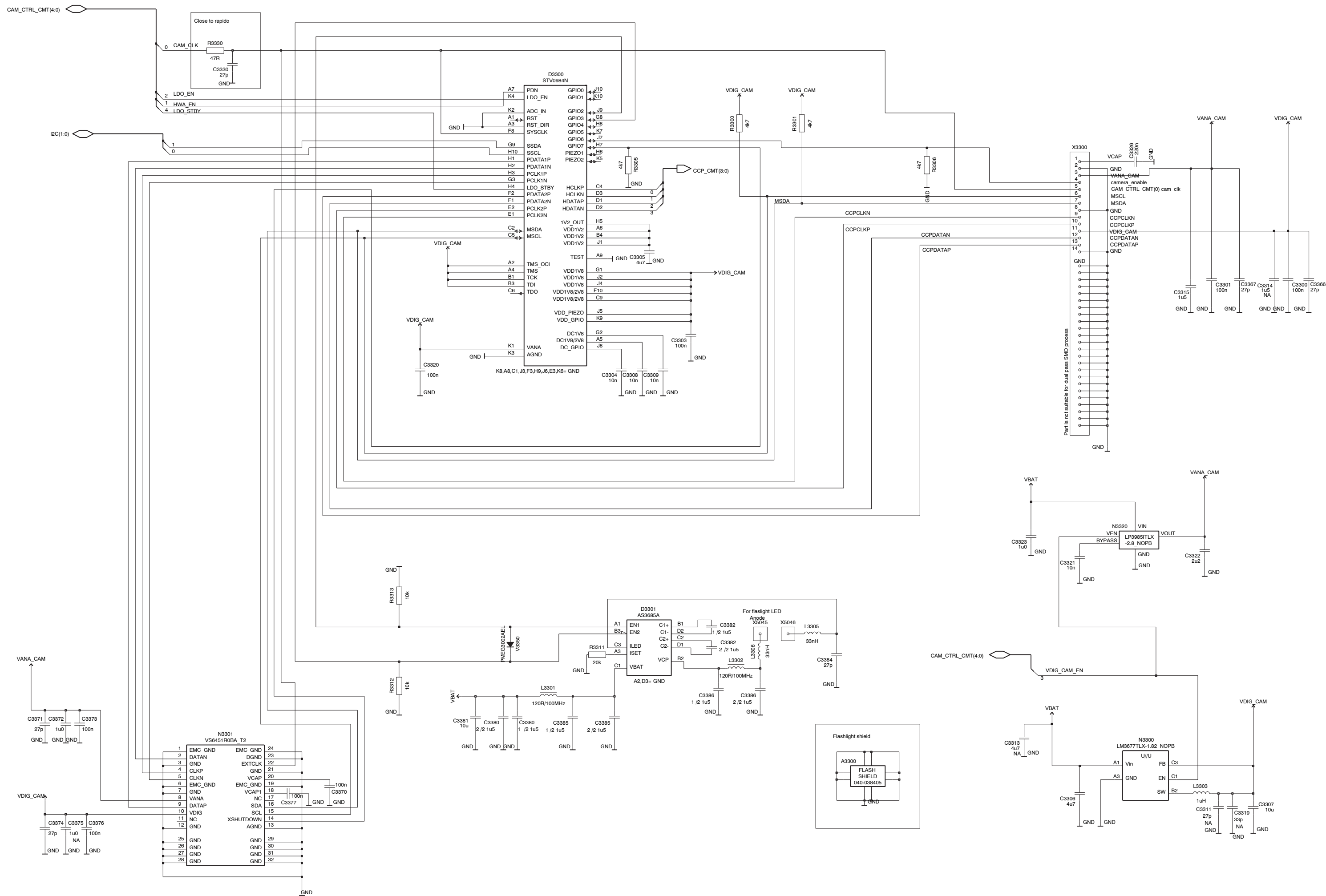
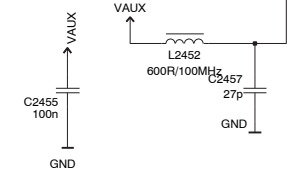
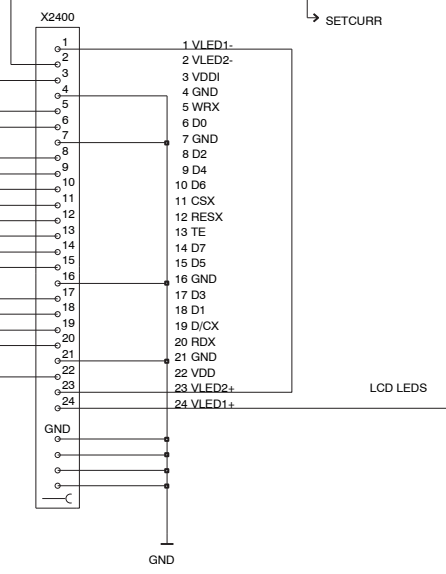
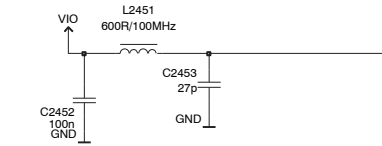
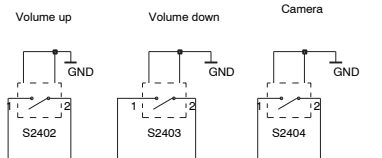
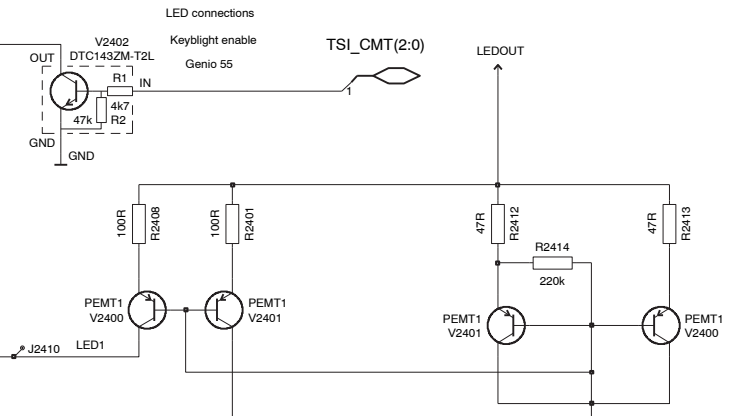
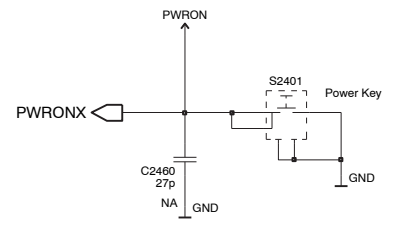
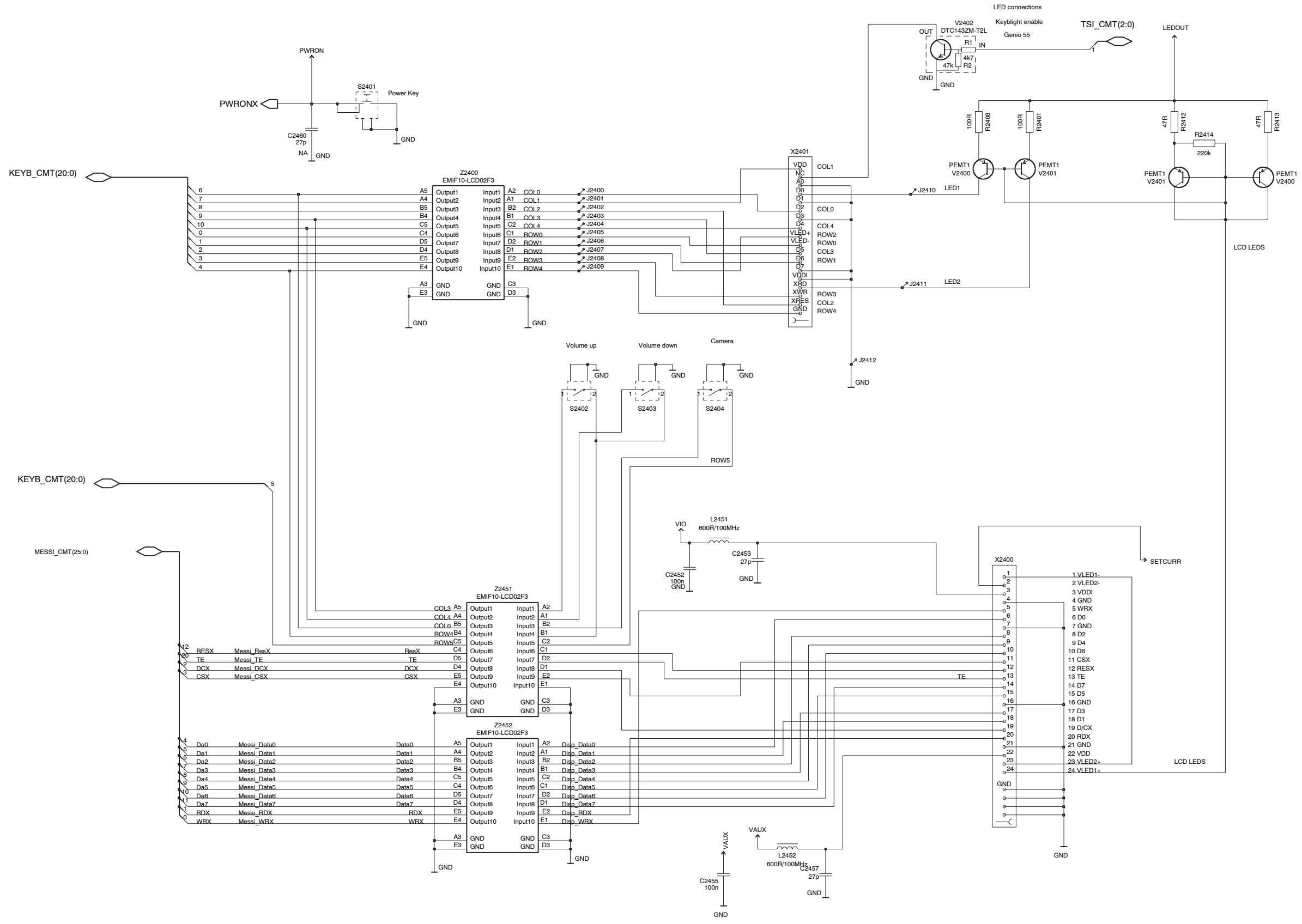
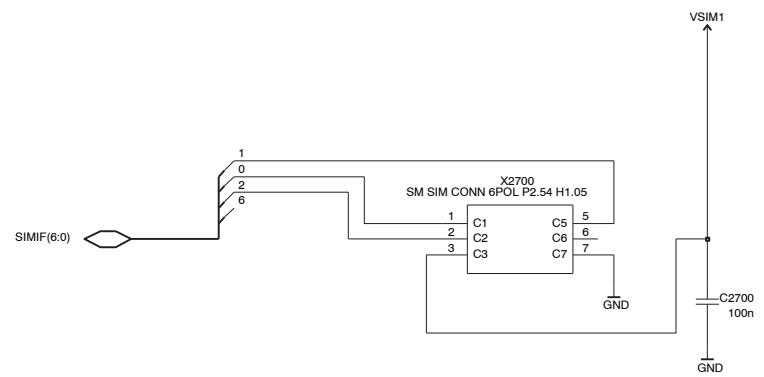

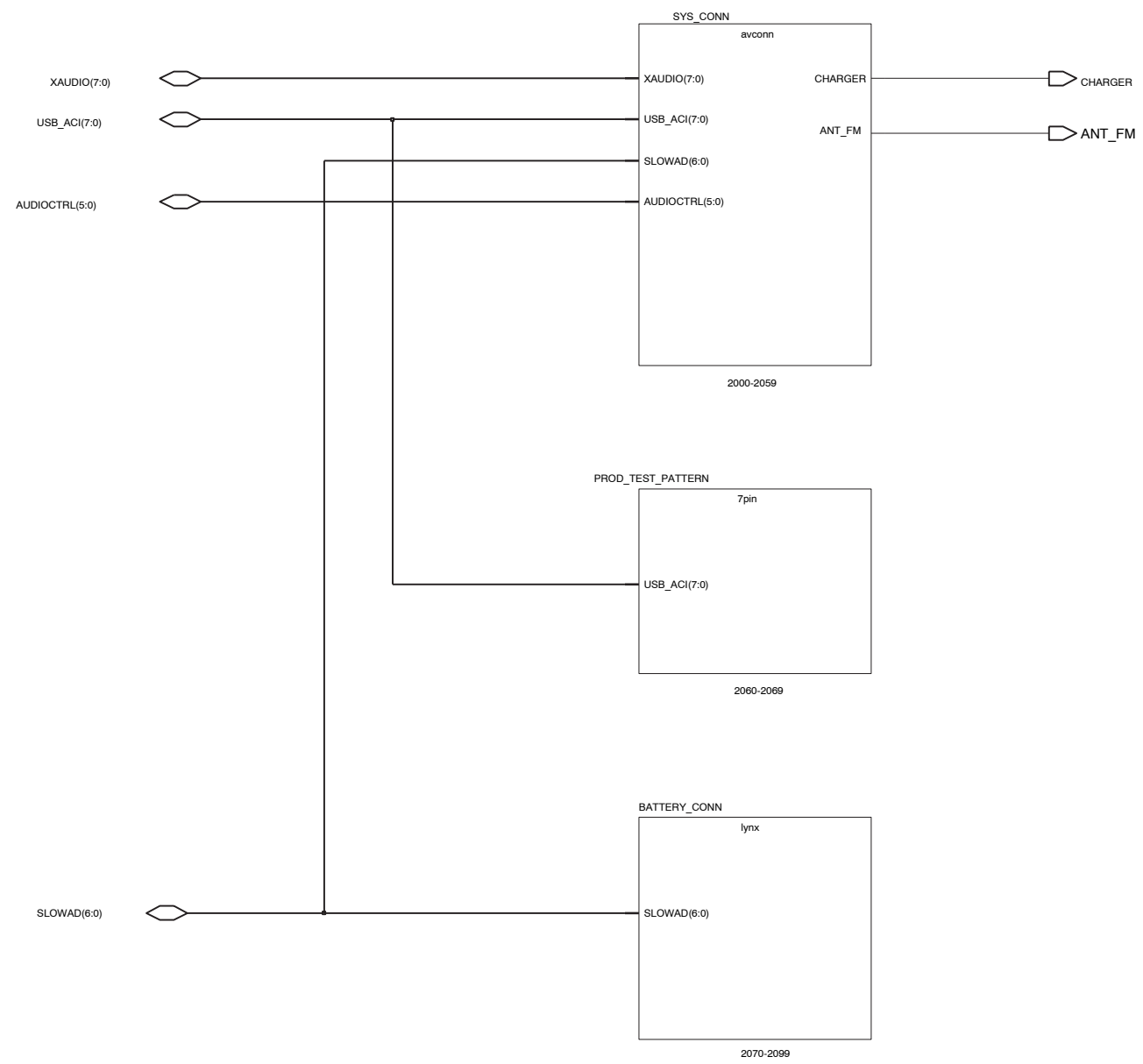

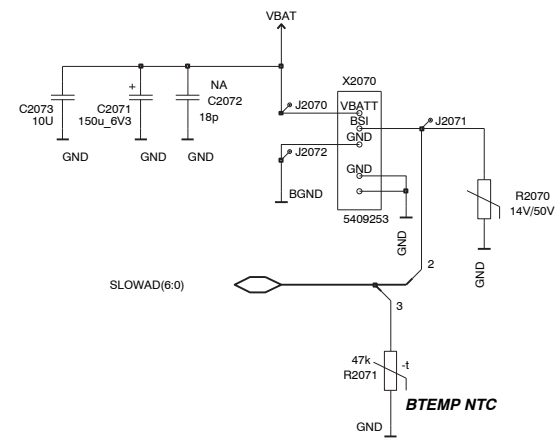

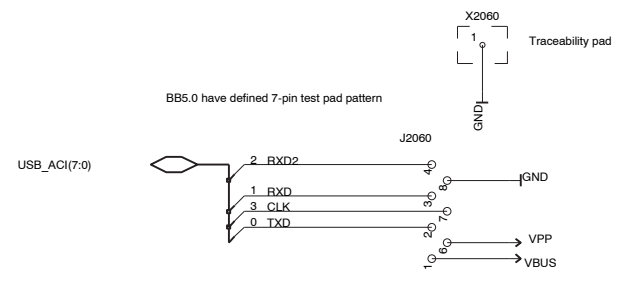

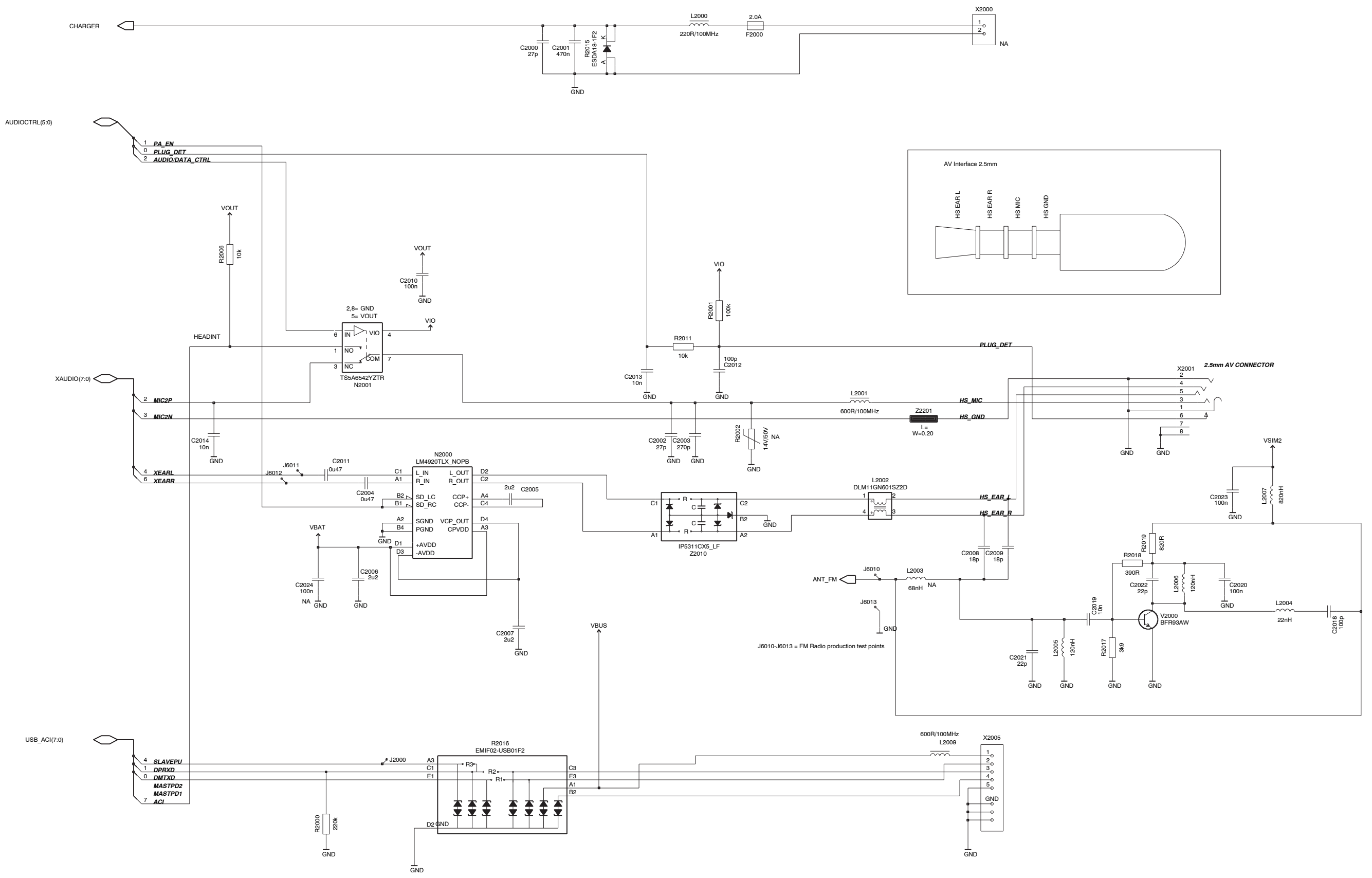

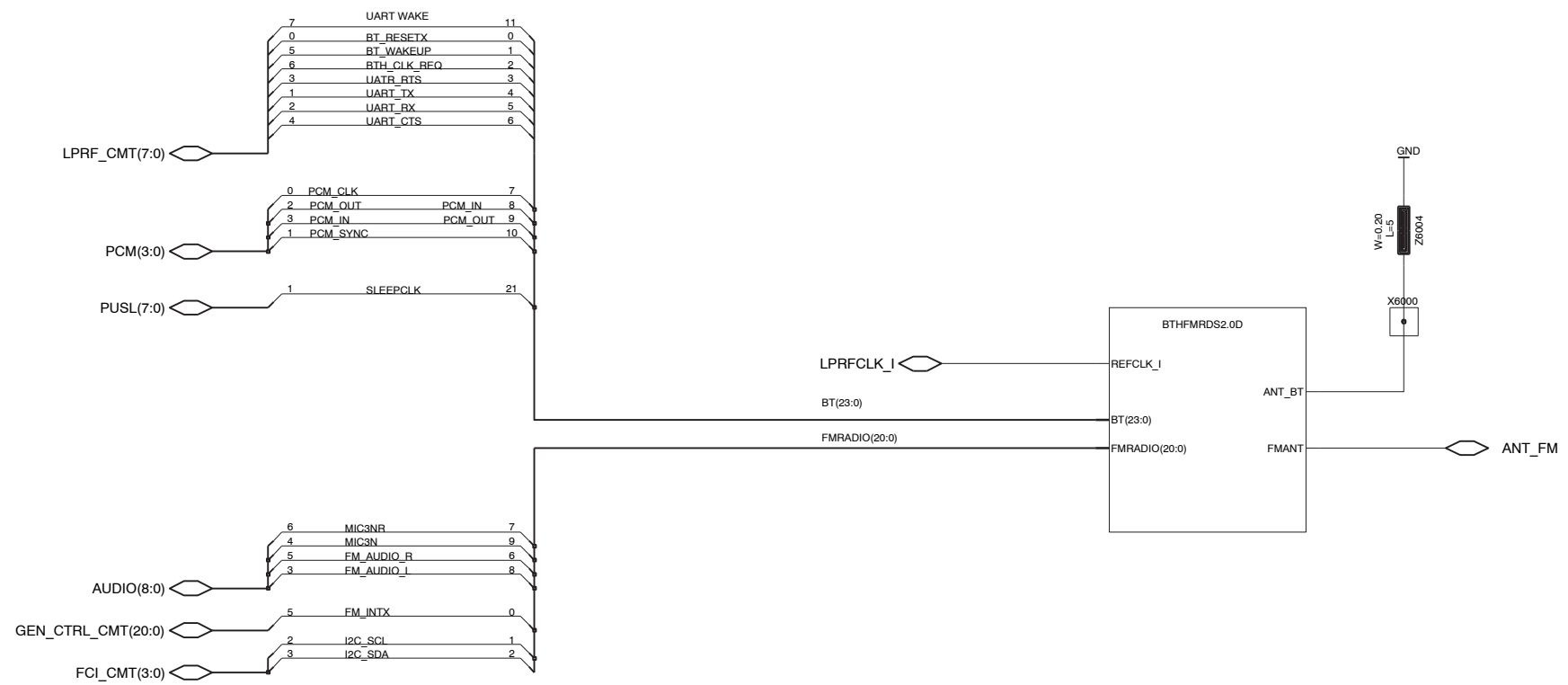

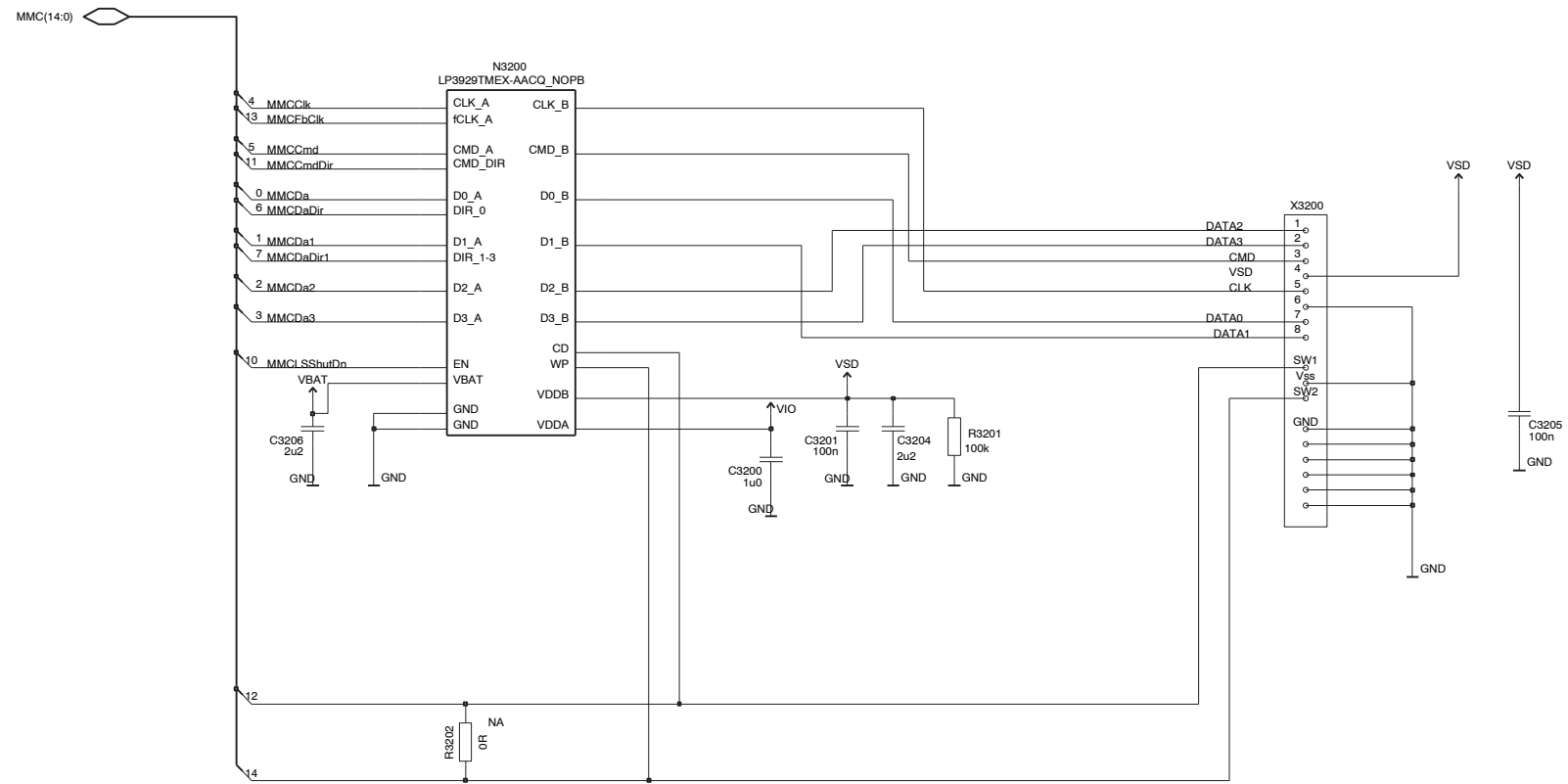

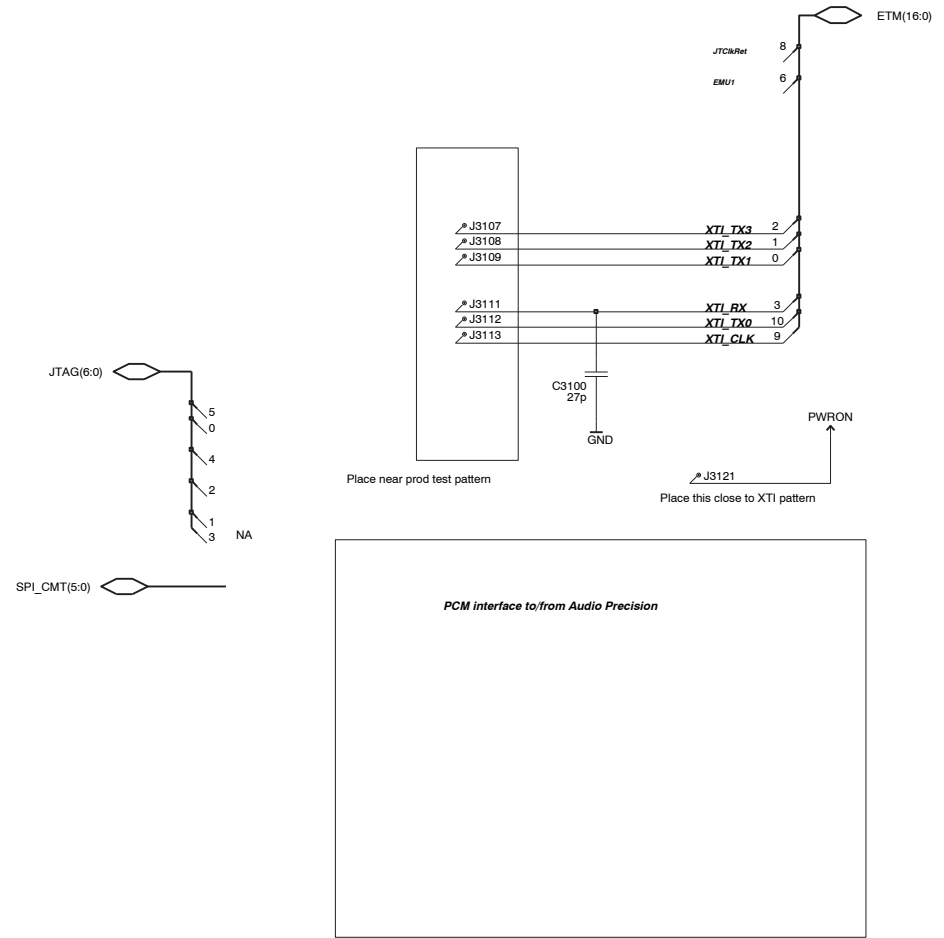

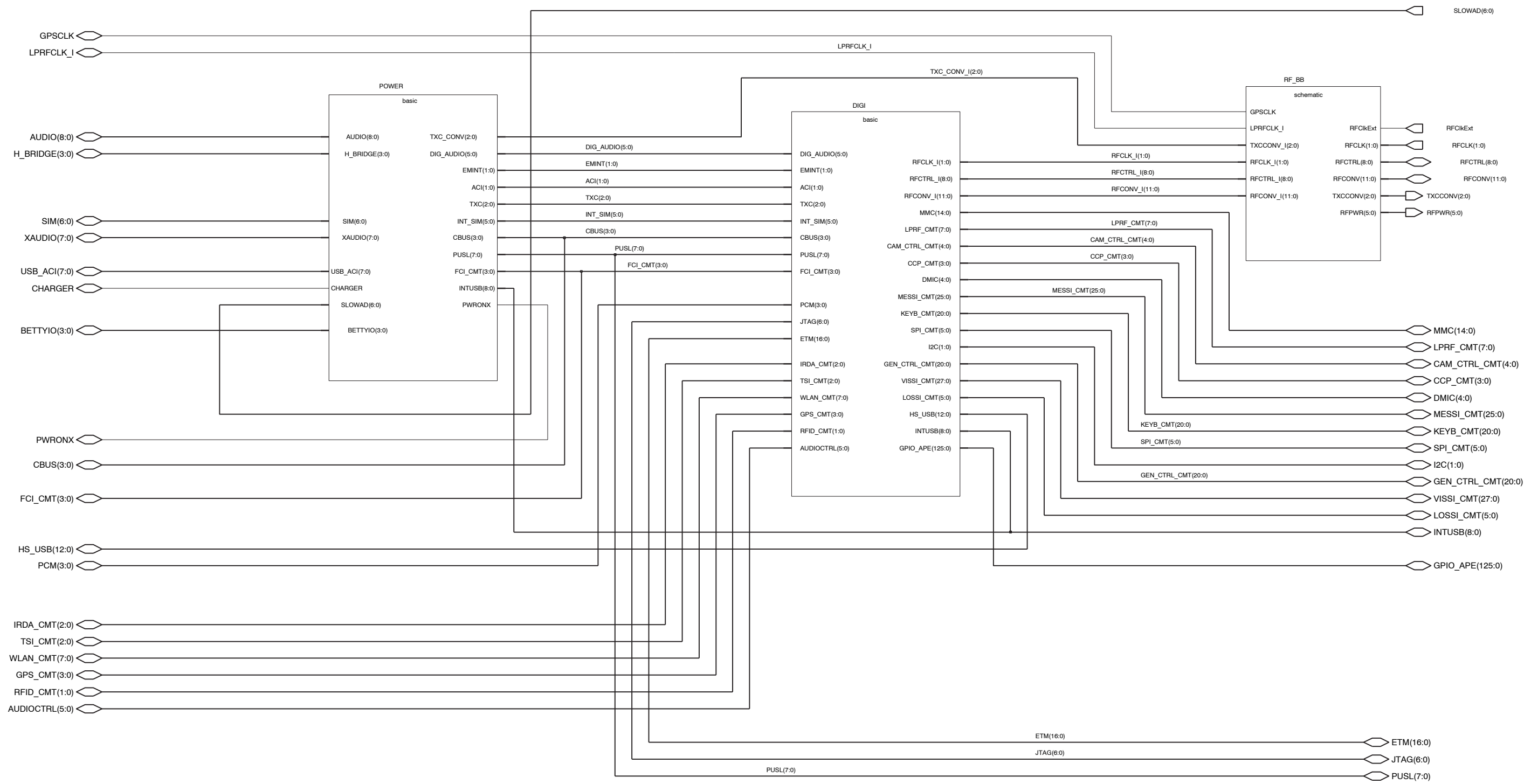

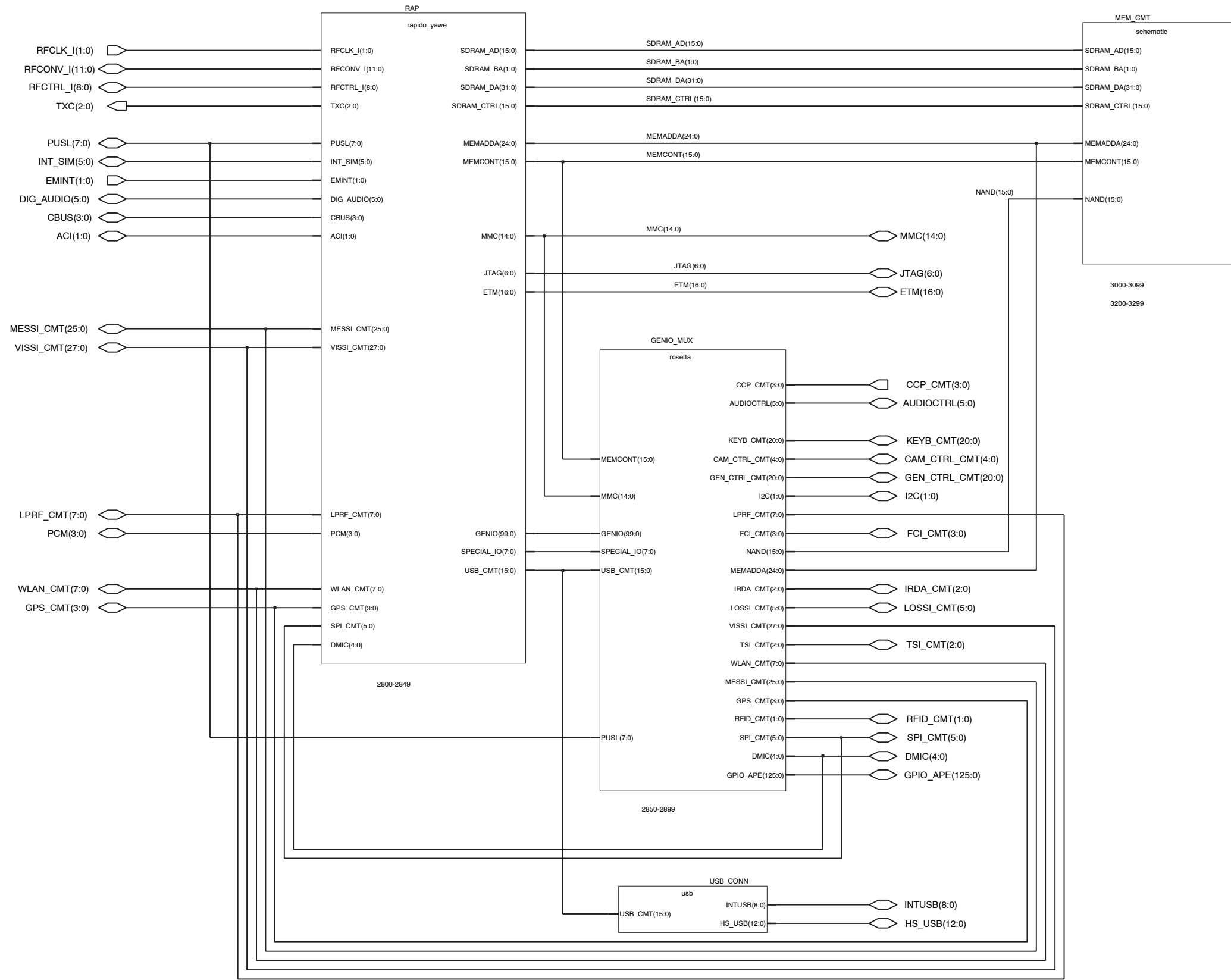

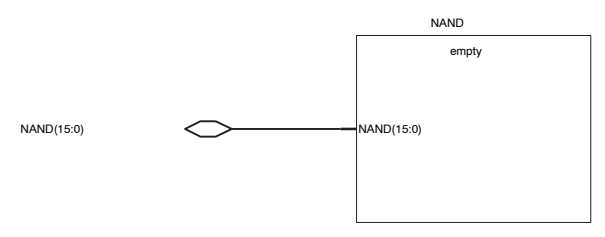
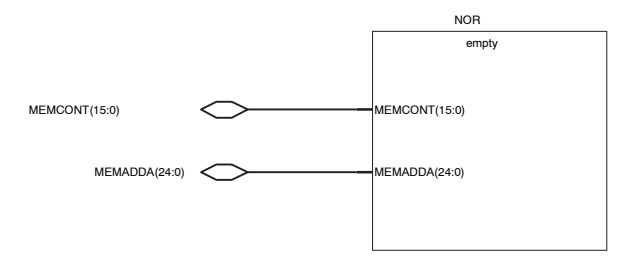
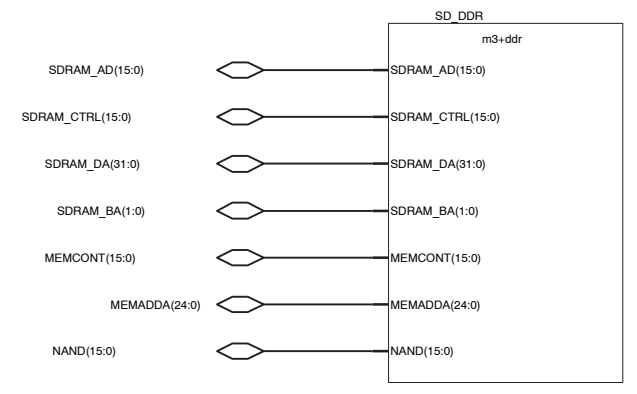

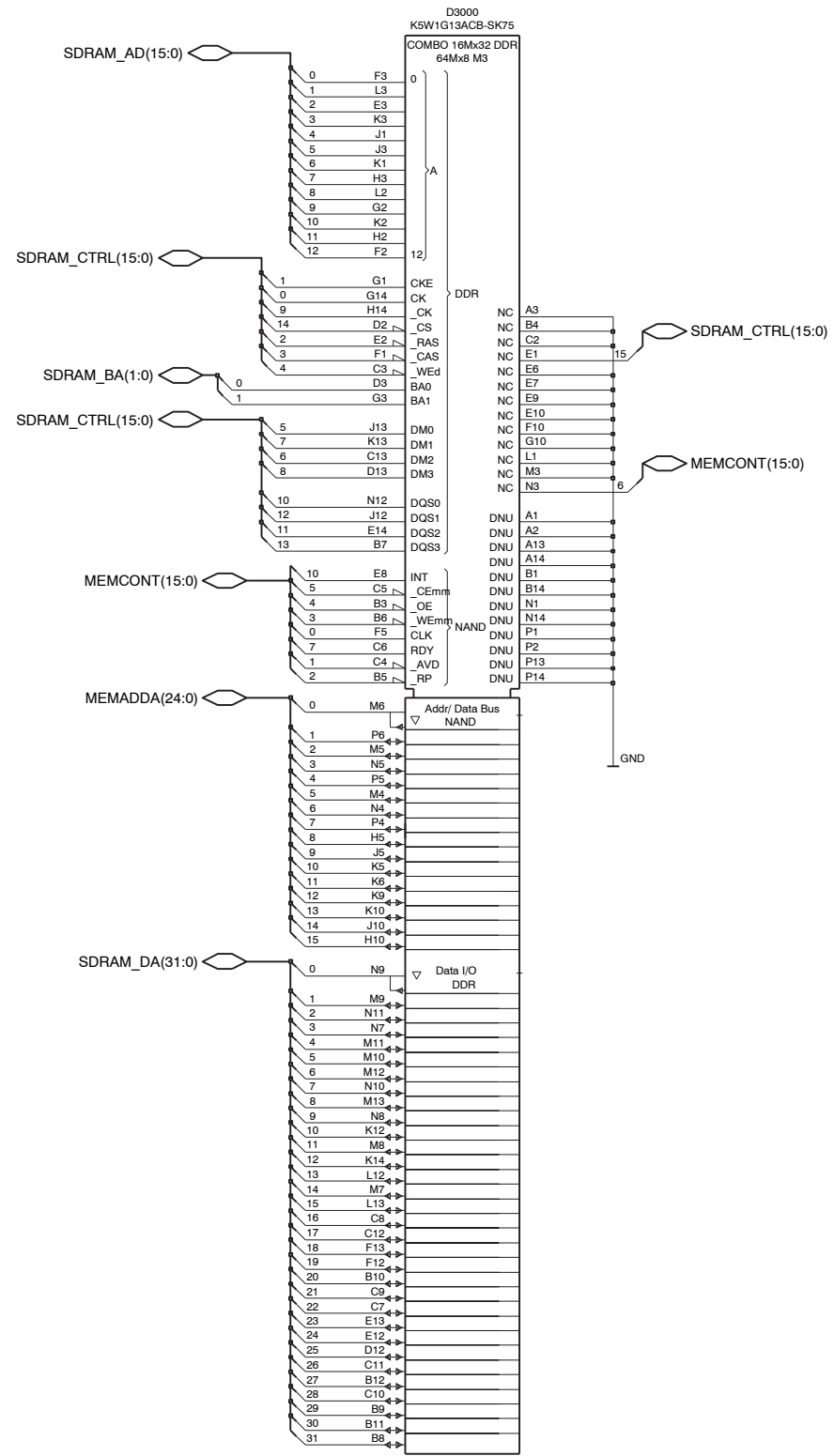
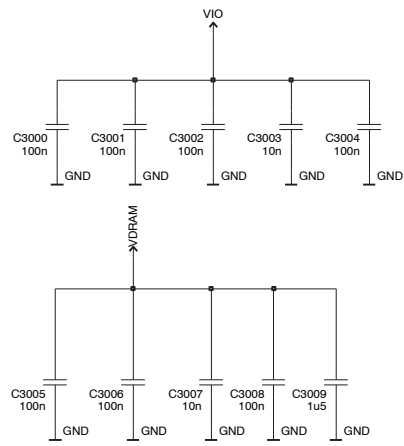

A11,D1,G12,H1,M2,P11- VDRAM
 A7,A8,B13,C14,G13,H13,M14,N13,P7,P8- VIO
 A5,E5- VIO
 K7,N2- VIO
 A6,A9,A12,D14,F14,J14,L14,N6,P9,P12- GND
 A10,C1,H12,J2,M1,P10- GND
 A4,B2,G5,K8,P3- GND

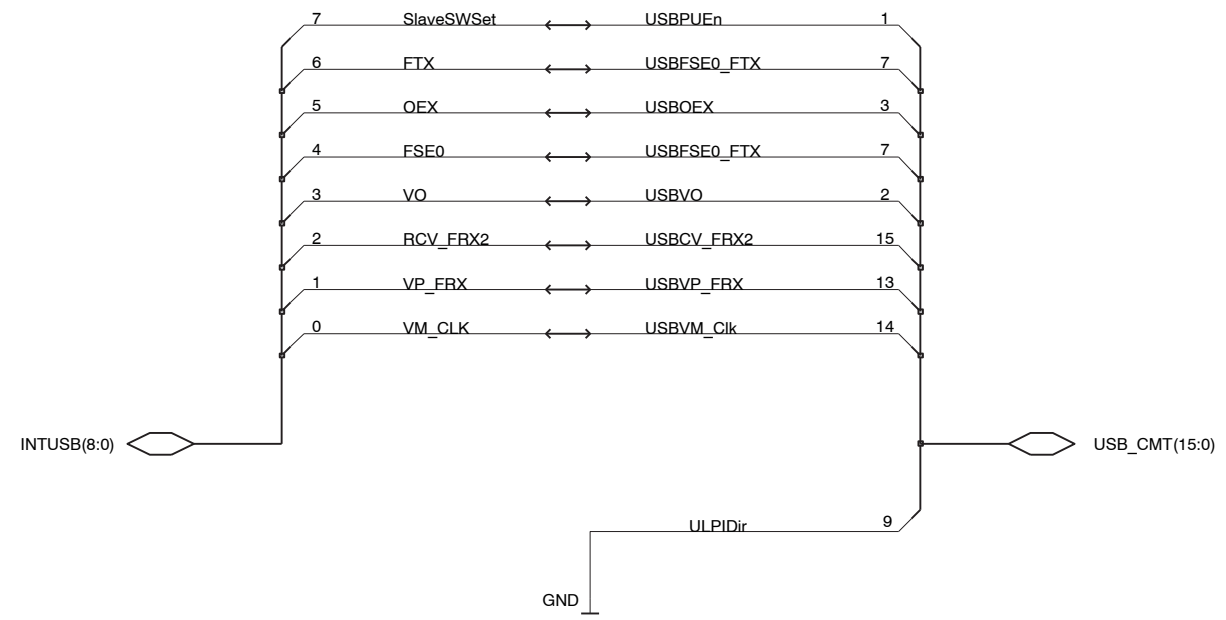

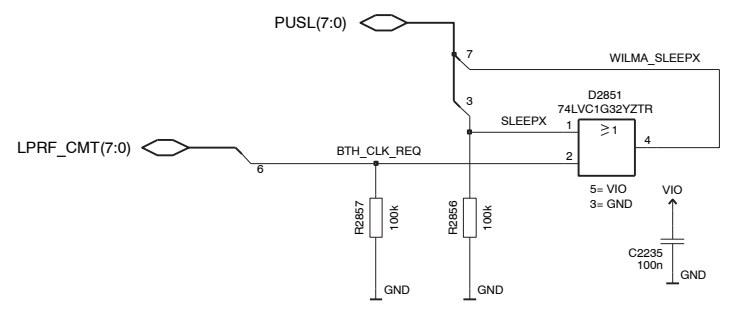
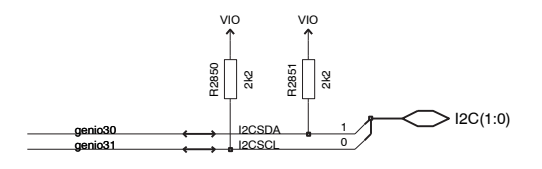
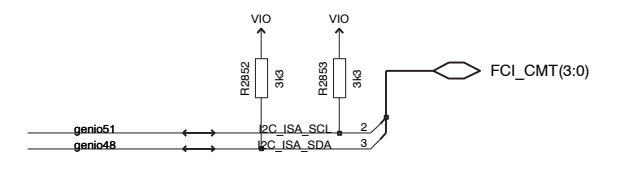
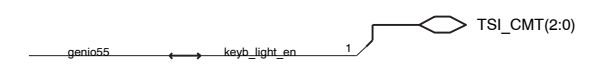
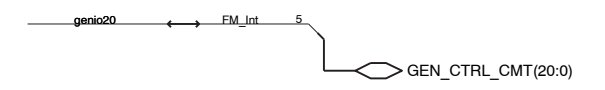
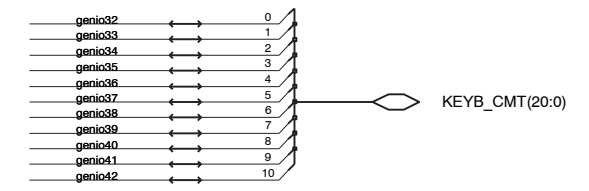
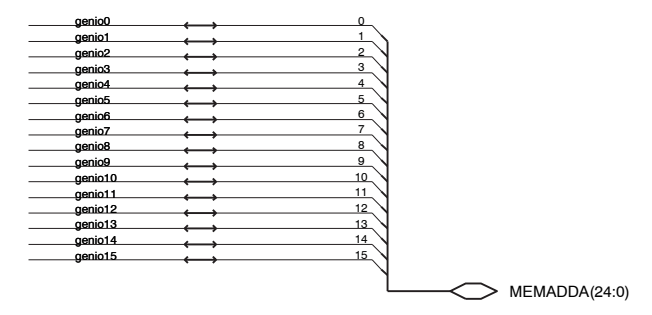
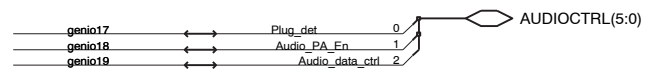
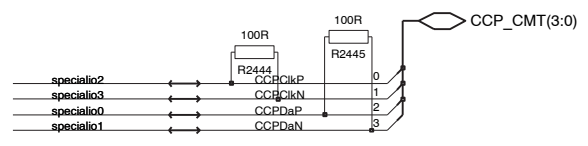
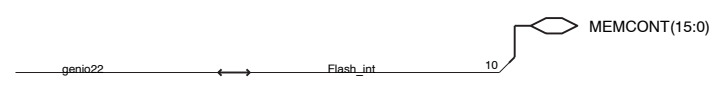
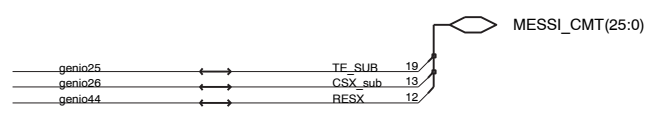
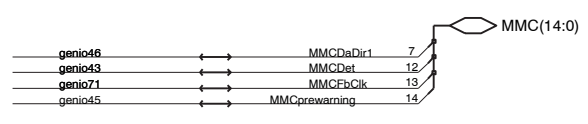
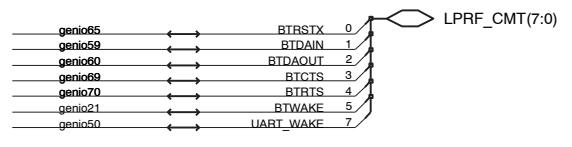
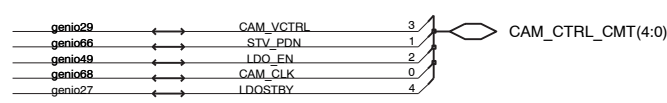
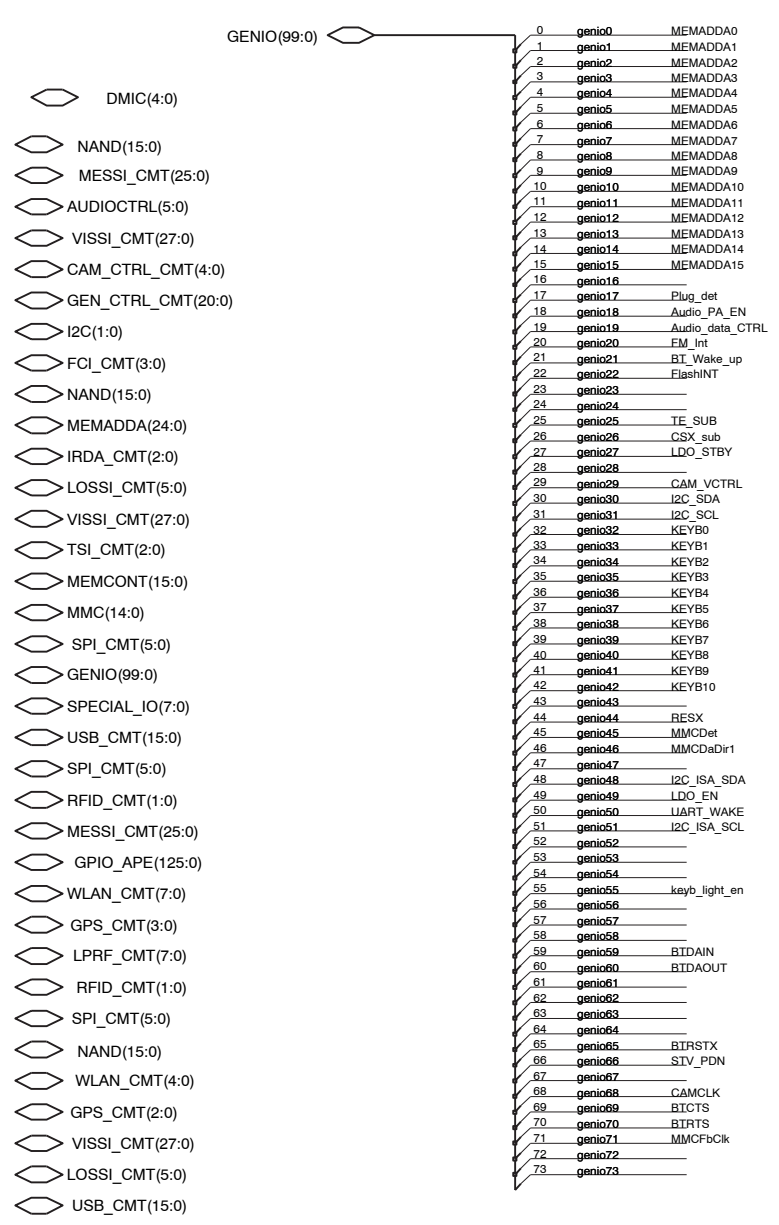

CBB5X

TOP SHEET

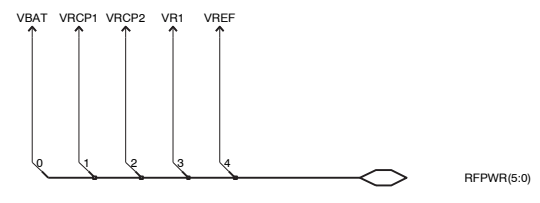
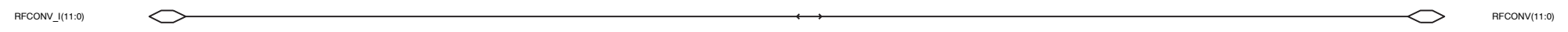
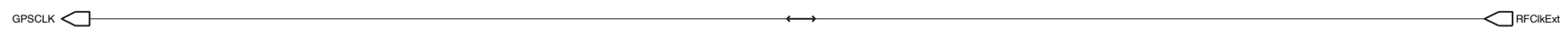
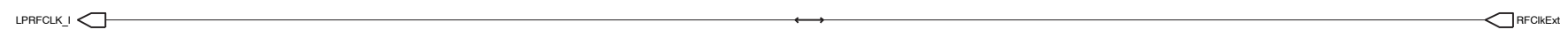
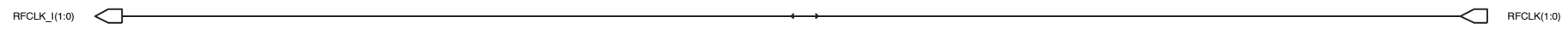

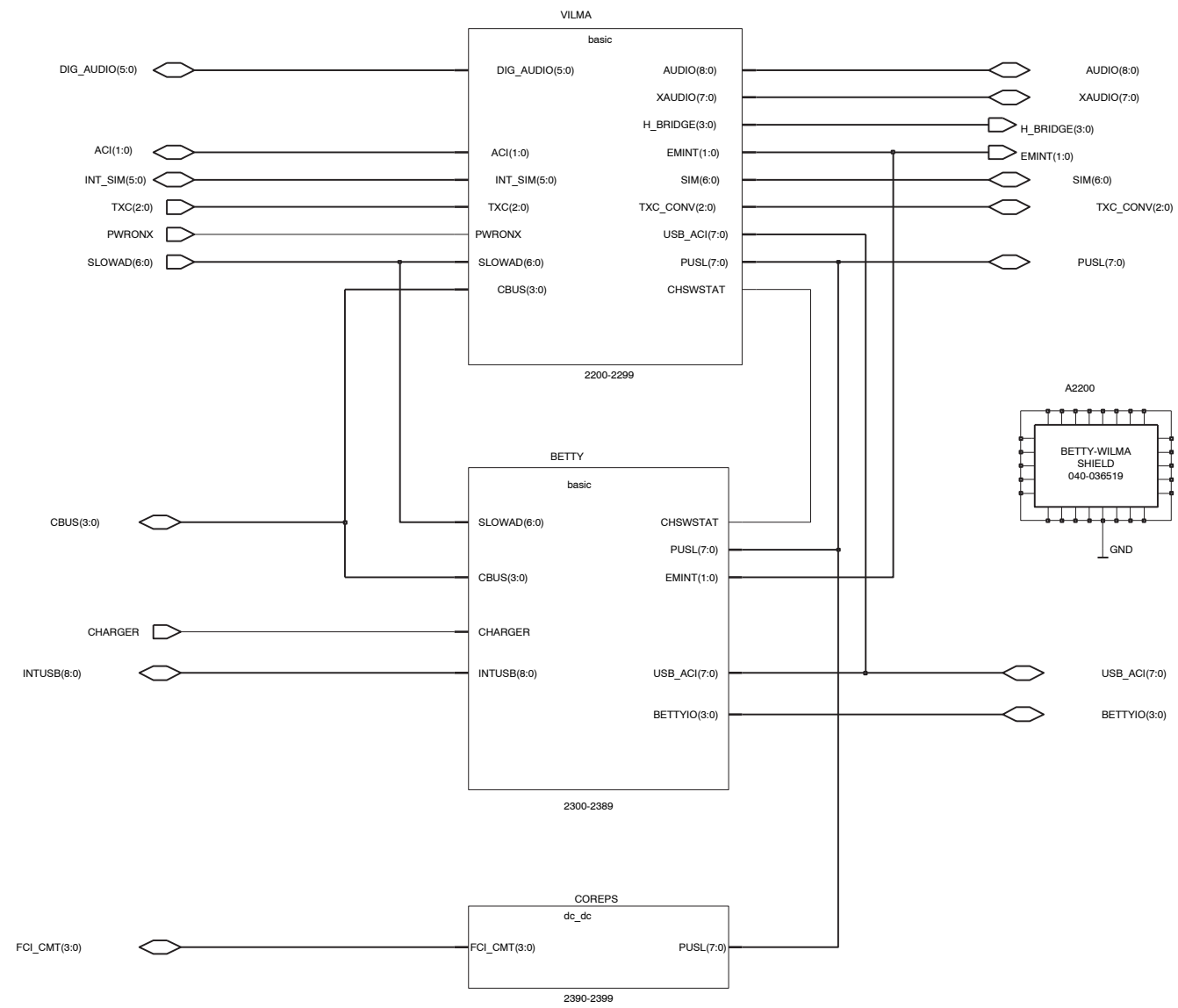

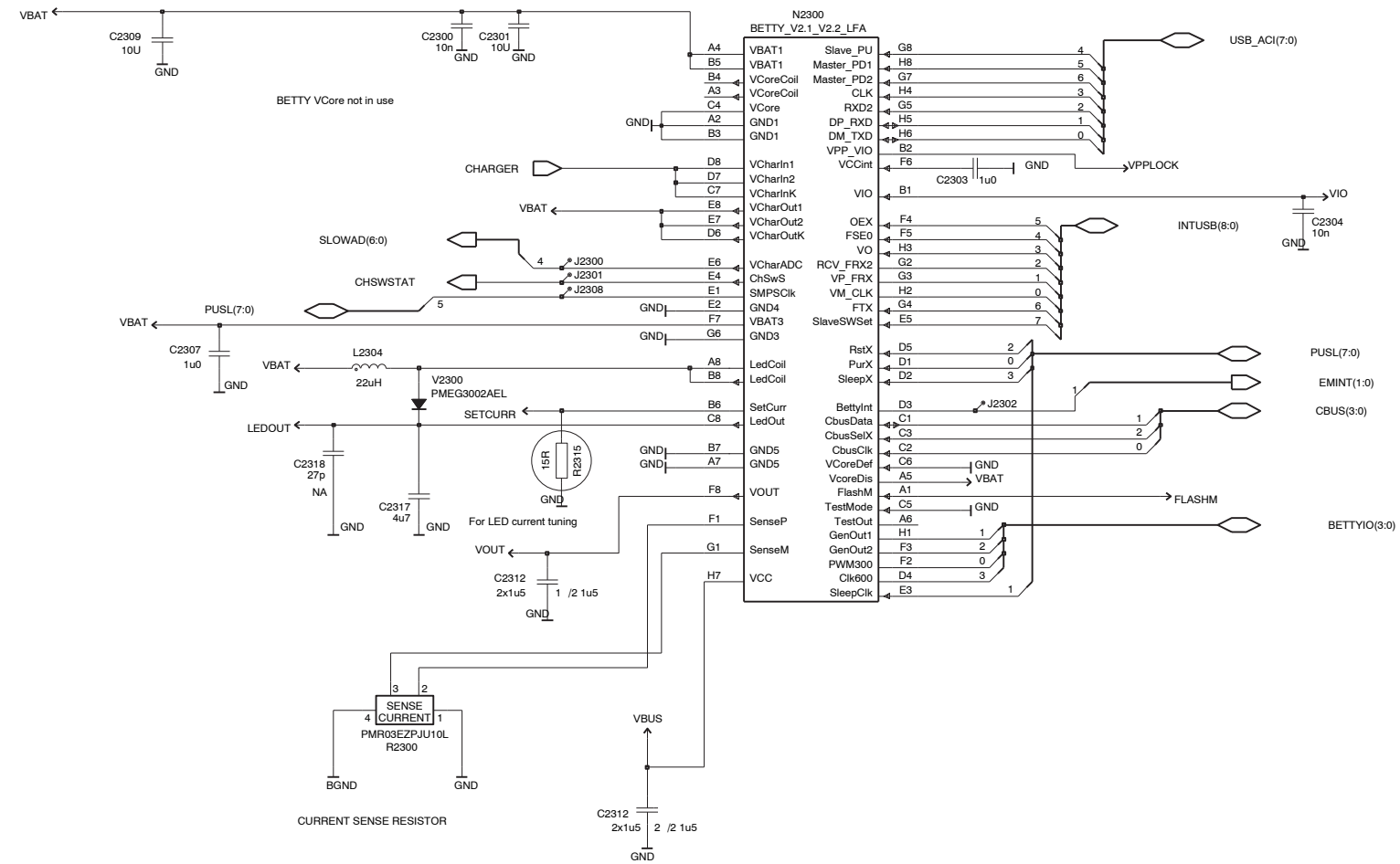

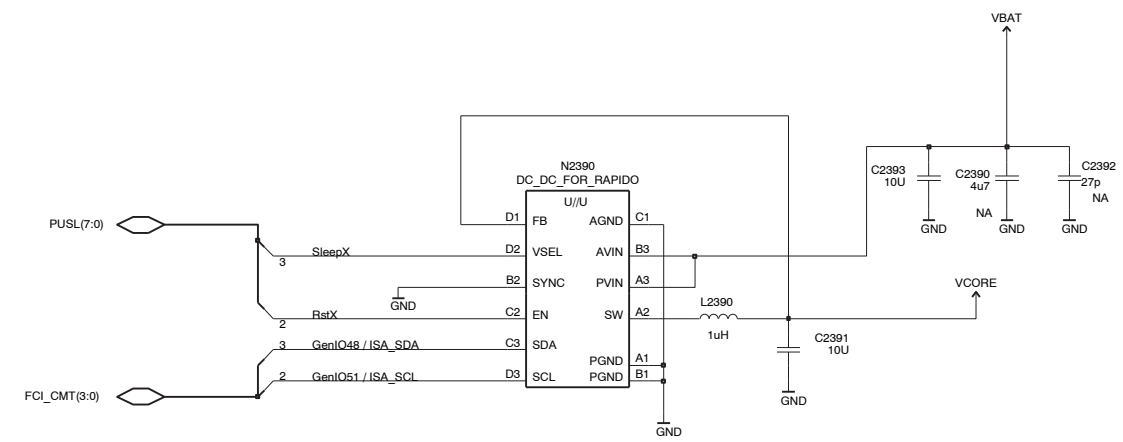

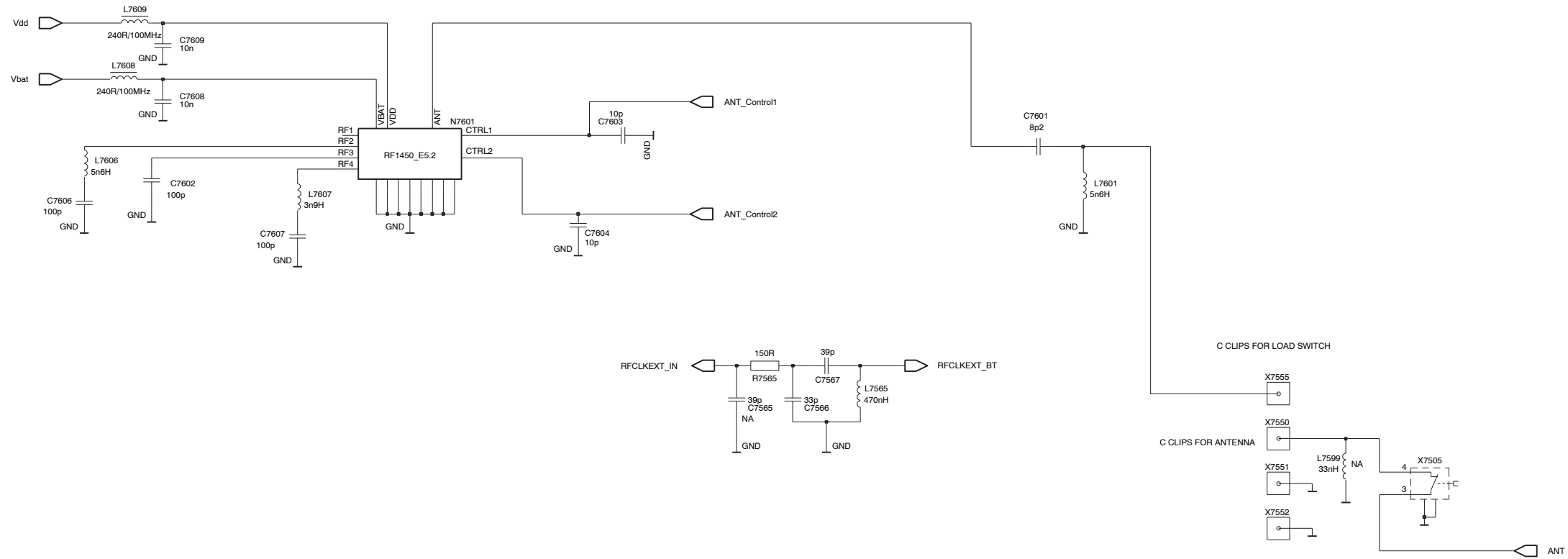

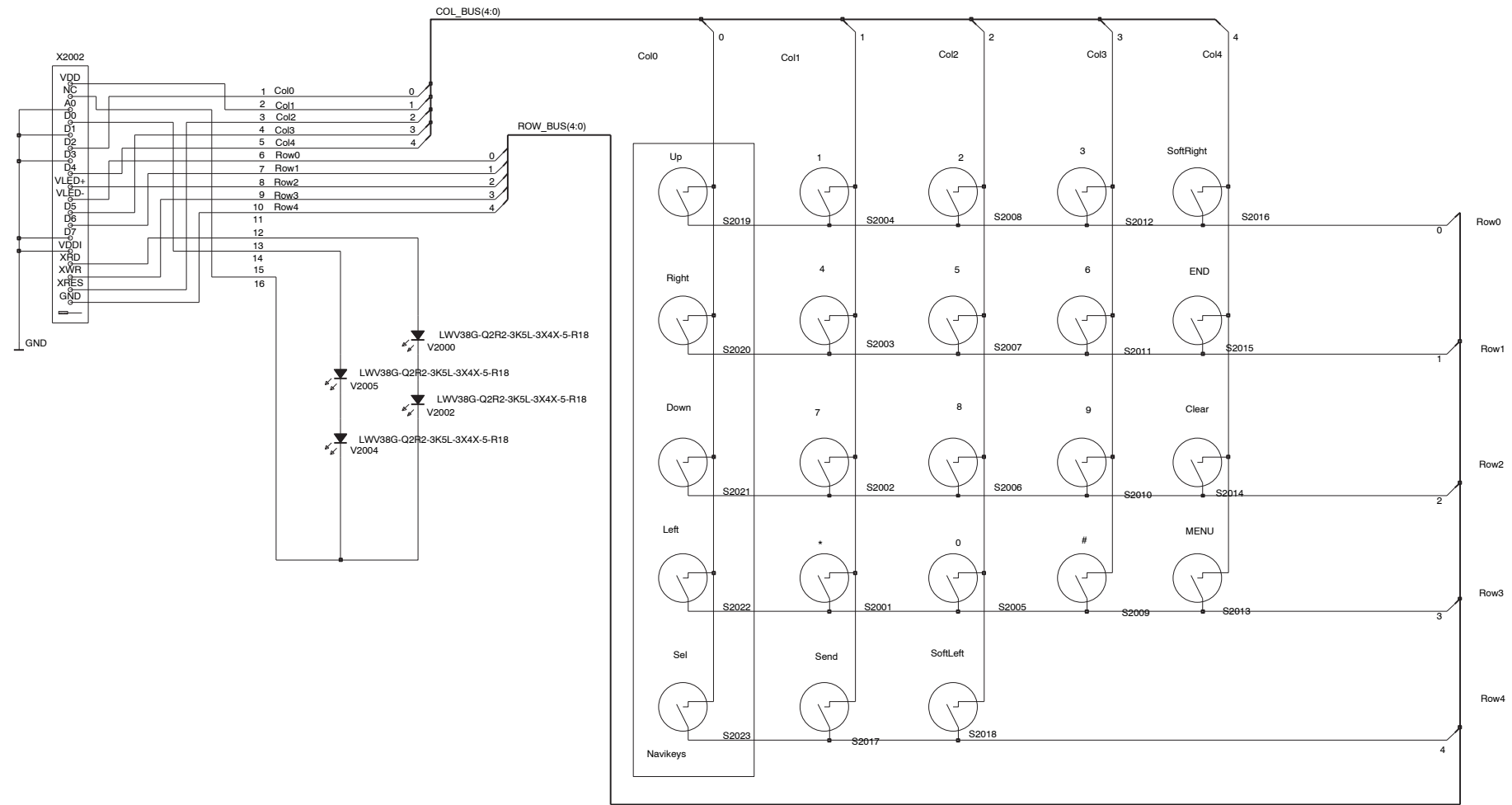



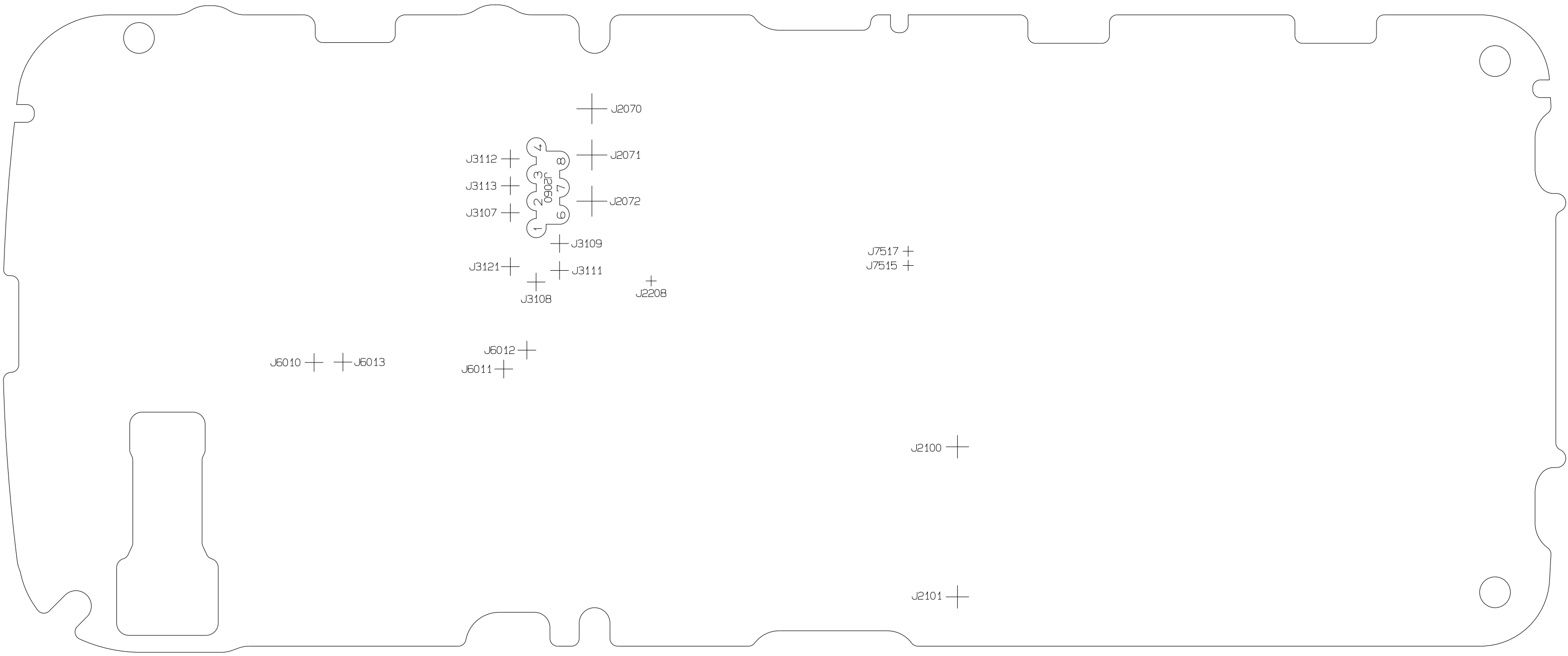

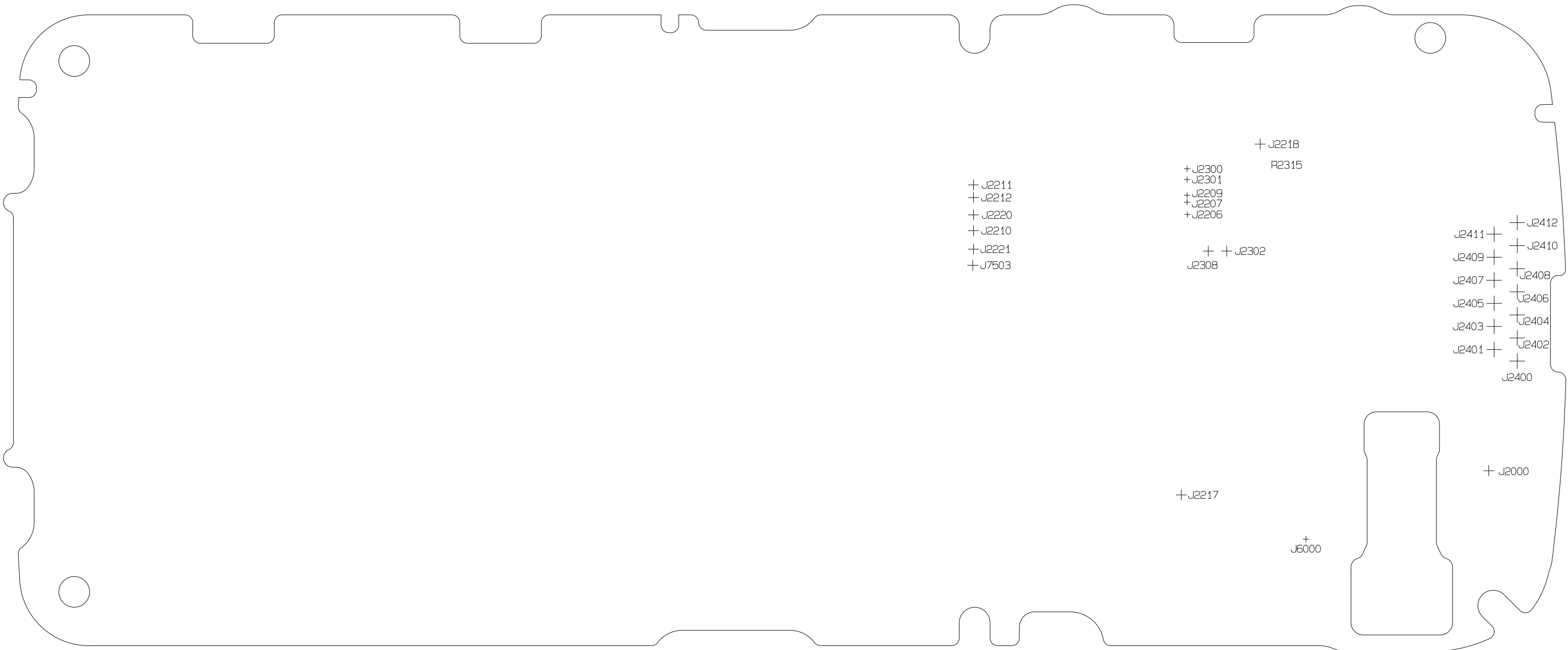

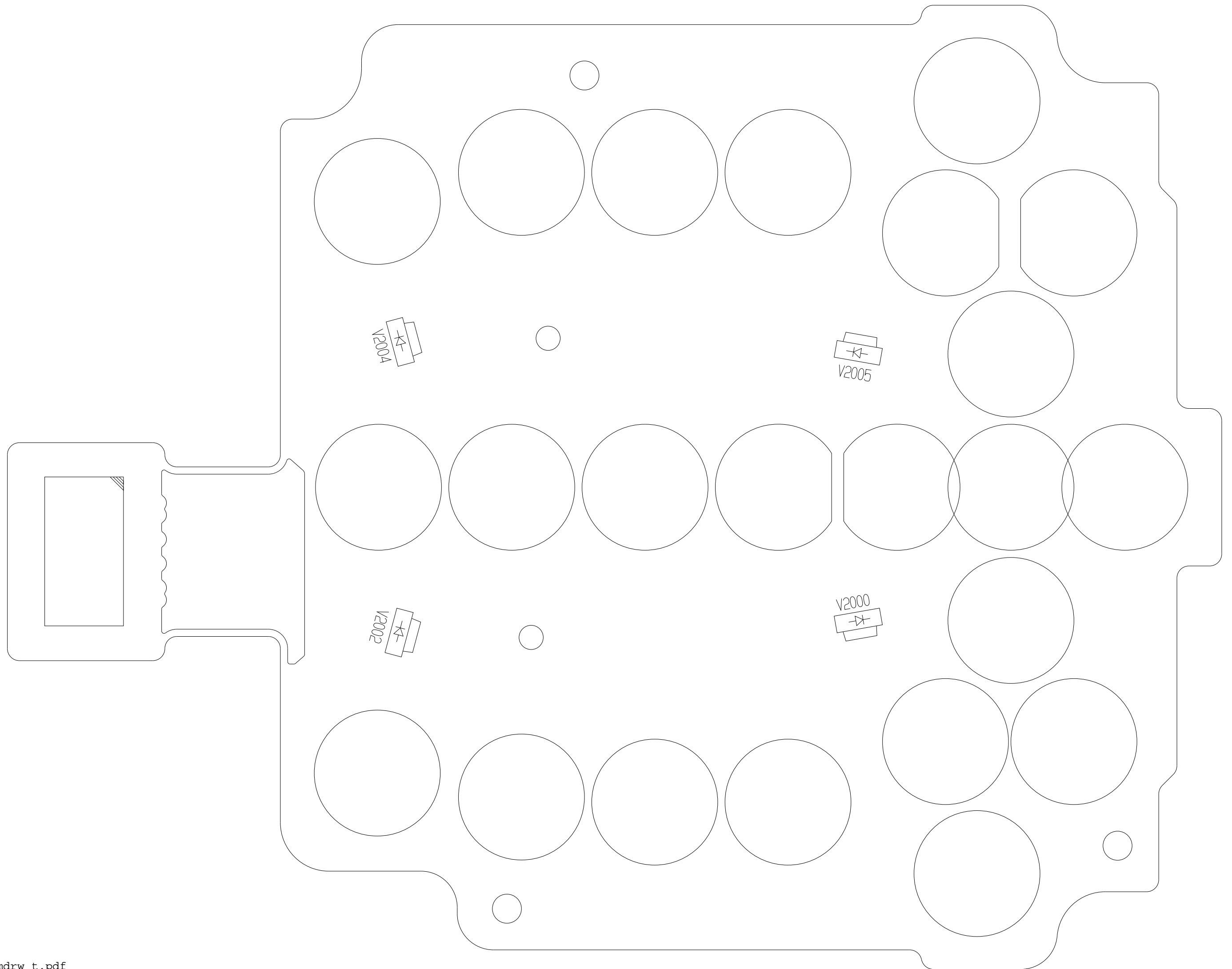

V2004

V2005

V2002

V2000